

SPINS
SOUTHERN PACIFIC INDUSTRIAL
NUMBERING SYSTEM

Spins is a standard method of identifying industries and switching zones, tracks and consignee loading and unloading spots. By giving zones, tracks and spots certain designated numbers, we are able to print switch lists with the exact location to which a customer's car is to be spotted.

A spins number contains up to six digits. The first two digits indicate the zone to which the car is destined, the next two digits indicate the track number within the zone, the last two digits are the actual spot or coded spot.

EXAMPLE: Spins coded 473701 means that the car is for Zone 47, Track 37, Spot 01 on that track.

Zone and Track number appear on switch targets. Spot signs are placed where customers normally load or unload their cars.

Spot signs are 6" x 6" green metal signs with 4" white reflectorized numbers. These signs are placed at center of a car spot for spotting if possible from either side of car.

RW Daily 548 62 5897

FOR YOUR SAFETY!

Be Alert to the Principal Sources
of Accidents!



970.190-195

**To Avoid A Painful Accident
Always Grip Air Hose Firmly
Before Opening Angle Cock!**

COYOTE TO WATSONVILLE JCT.

HOLLISTER BR.

SANTA CRUZ BR.

DAVENPORT BR.

MONTEREY BR.

SALINAS SUBDIVISION

**WATSONVILLE
ZONES**

**SALINAS
ZONES**

11 THRU 18



FOR YOUR SAFETY!

Be Alert to the Principal Sources
of Accidents!

R W DANLEY 548 62 5897

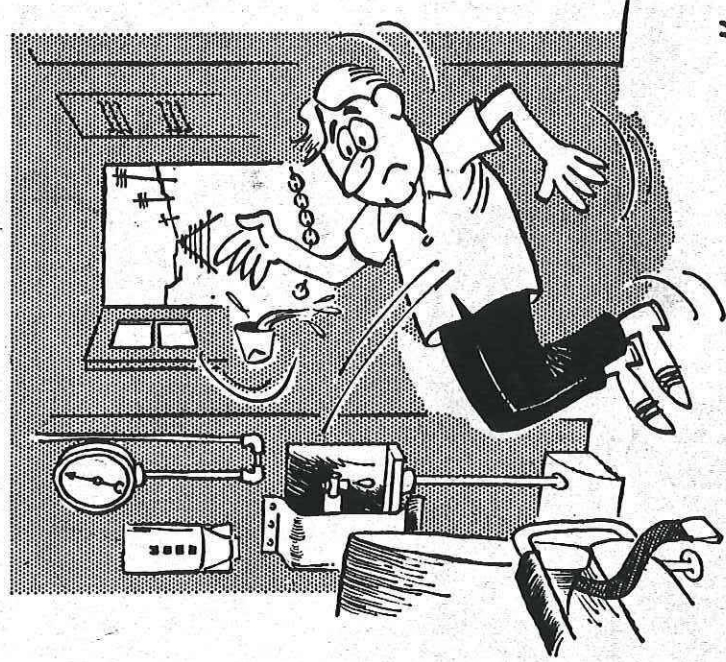

Watch Out for Slack Action!

Don't Be A Fall Guy



Procedures listed below must be complied with in filling out the printed lists.

1. Cars properly spotted or placed opposite each show the letter "S" and write time placed to the nearest hour.
2. Cars not spotted according to list, opposite each show "00" for off spot code, actual location-track and or where car was placed and reason why car could not be spotted.
3. Cars pulled from the industry opposite each show the letter "P" write the time to the nearest hour, if car is left in the industrial area, show track and time.

4. Respotted or switched car, opposite each show the letter "R", new location (Zone, Track and Spot) of car and write time to closest hour.
5. Write job number, date, name and on duty time on all lists in space provided.
6. Any cars not shown on the printed lists and are pulled from an industry, write car initial and number as well as track pulled from on the Zone-Pull list.
7. Return finished printed spot and pull lists as soon as possible to instructed office.
8. If not furnished a spot and or pull list, then all cars switched must be listed on a Form 16 and turned in at instructed office.

SPOTTING CODES

- (*) Asterisk before and after a spot number indicates preferred spots.
- SPECIAL SPOT NUMBER CODED
The last two digits of a SPINS number may convey a special meaning and are listed below:
- 90 Team track spotting
 - 91 Storage track
 - 92 Denotes industry will either do the switching or furnish a switch list
 - 93 Crane spotting
 - 94 Hopper dump

- 95 Dock spotting
- 96 Piggyback
- 97 Auto Ramp
- 98 Interchange to other railroads
- 99 Open area where not possible to put up spot signs
- 00 When a car cannot be spotted according to the switch list and is left off spot, 00 will be indicated on the returned list. If car is left on a track other than designated on list, Track number & Spot where car is left will be shown in addition to 00

LANDMARK SYMBOL LEGEND

Sheet 1

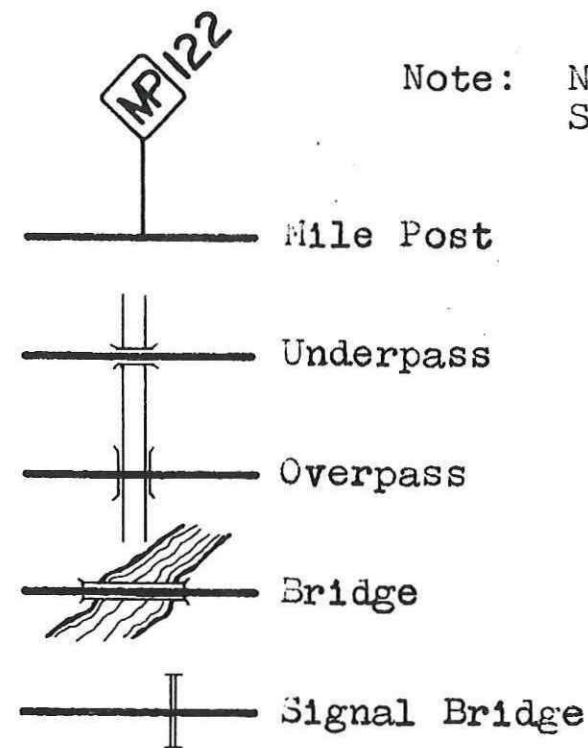

Note: Not to be used in place or instead of Special Instructions or Timetable Bulletins

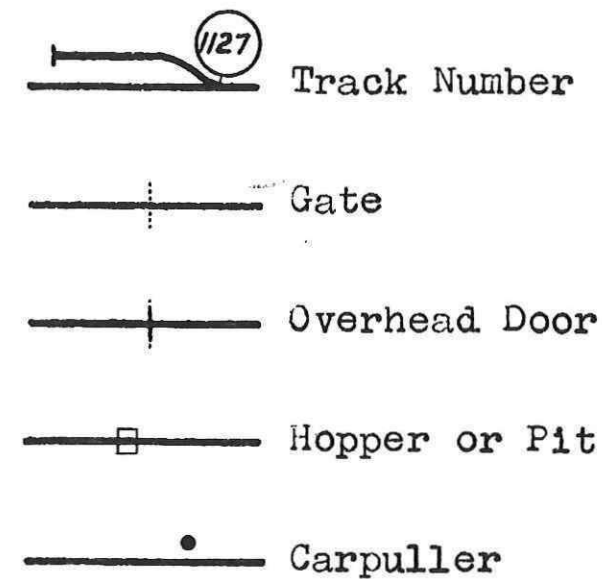

(cont'd)

LANDMARK SYMBOL LEGEND

Sheet 2

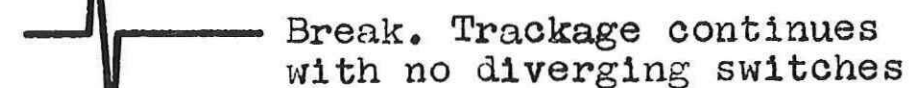
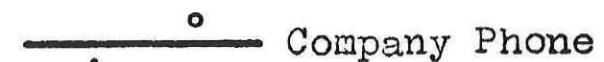
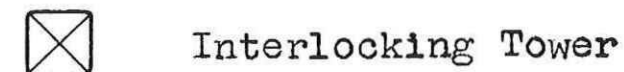
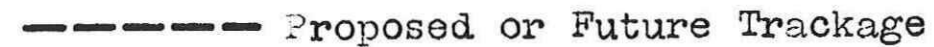
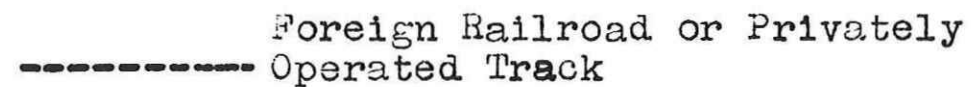
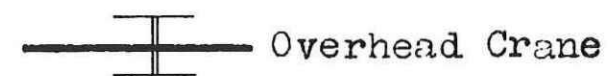
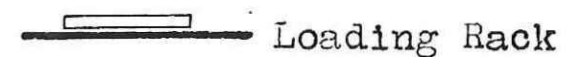
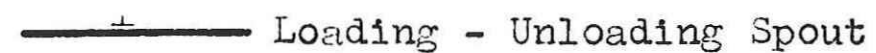

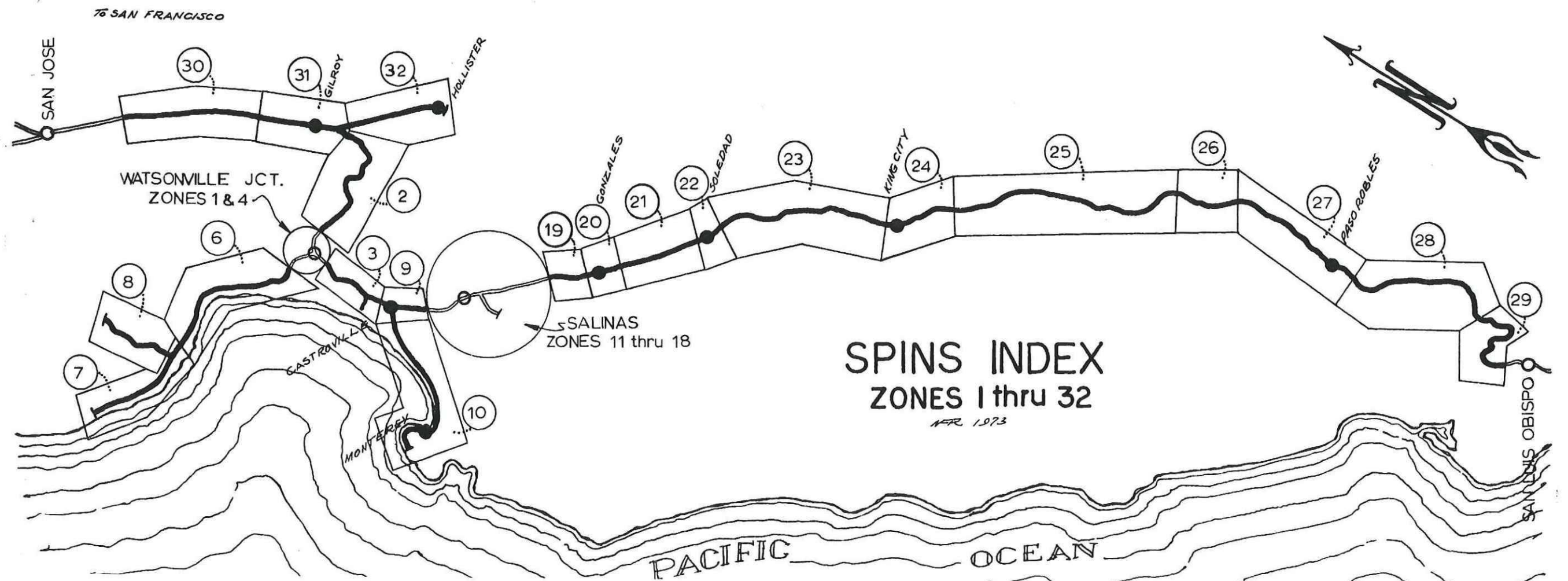

TO SAN FRANCISCO

MP 99

MP 100

TO LOS ANGELES

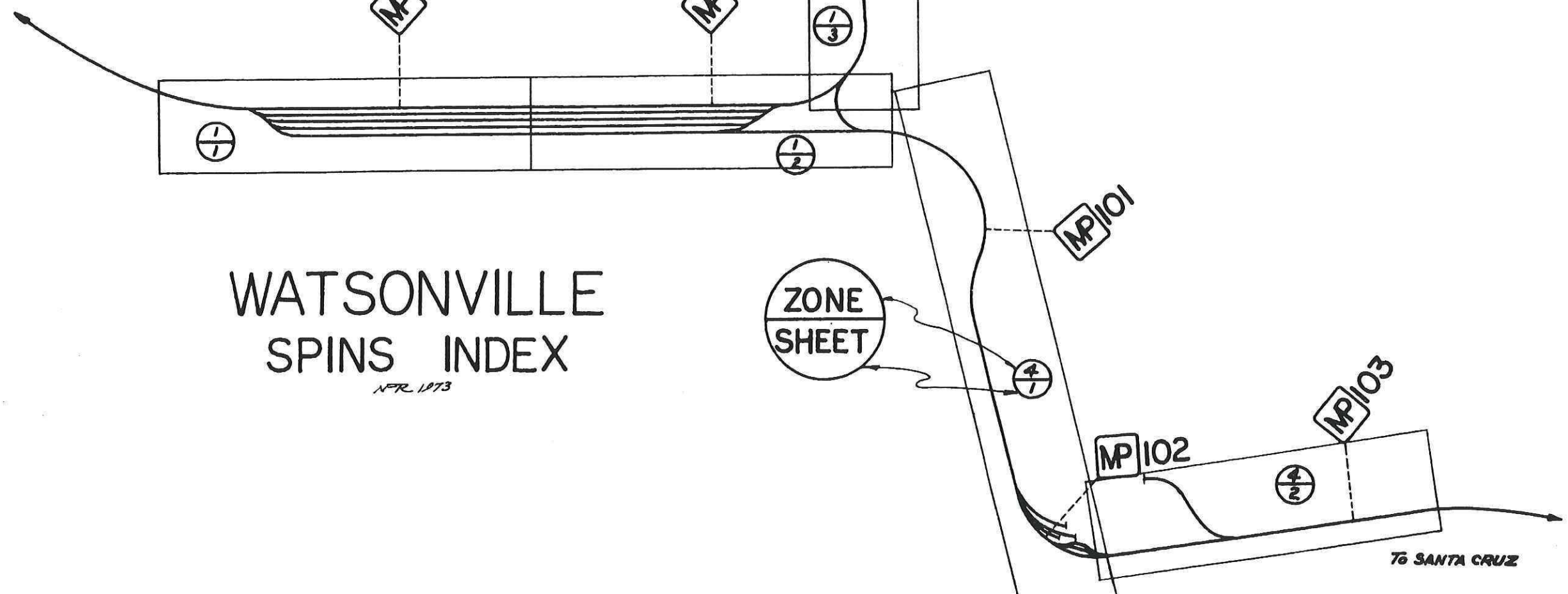

WATSONVILLE SPINS INDEX

NFR 1973

ZONE
SHEET

TO SANTA CRUZ

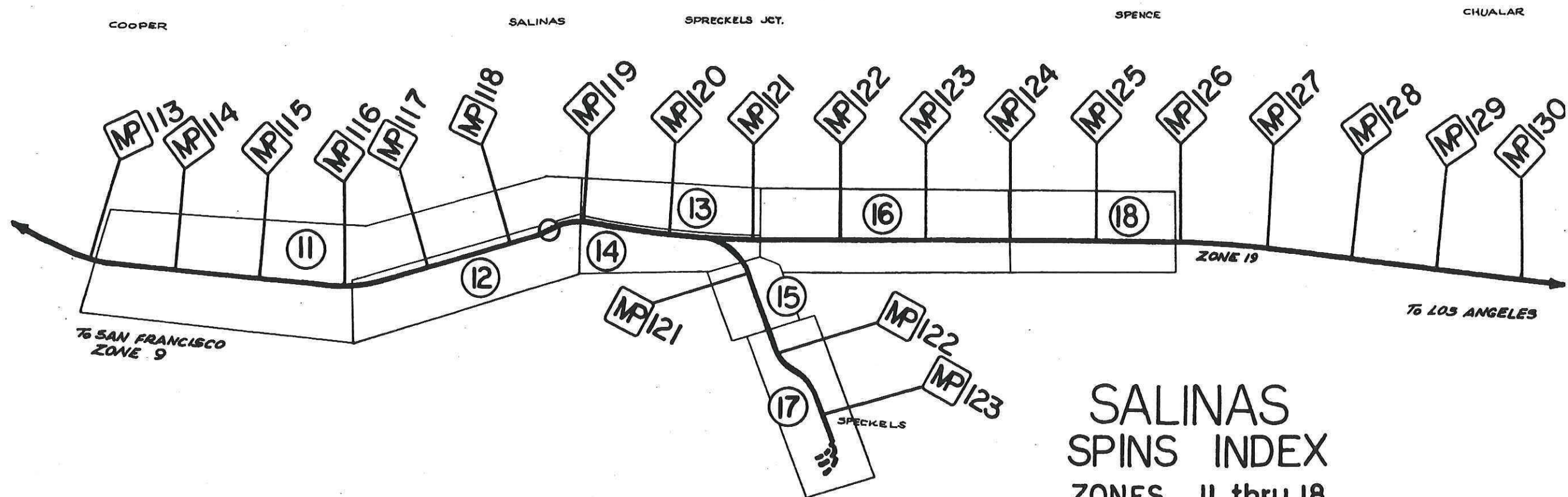

SALINAS
SPINS INDEX
ZONES 11 thru 18

NFR 1973

ZONE 1
(Watsonville Jct.)

<u>Track</u>	<u>Industry</u>	<u>Code/Spot</u>	<u>Track</u>	<u>Industry</u>	<u>Code/Spot</u>
110	Calif. Farm Products	95 4,5,6,7	145	Marinovich	1,2,3,4
110	Smuckers	95 4,5,6,7	146	Crosetti	95
112	Vacant (Out of service)	95	147	Crosetti	99
113	Vacant	95	148	Matiasevich	1,2,3,4
115	Vacant	95	171	Watkins	
116	Vacant	95	172	Team Track	90-97
117	Lead Track				
139	Old Corral Track	99-91			
140	Lead Track				
140	Matiasevich (end)	99			
141	Richfield Oil	95 1			
141	Smuckers	4, 5			
142	Nestle	1,2,3			
143	Marinovich	4, 5			
144	Nestle	1, 2			

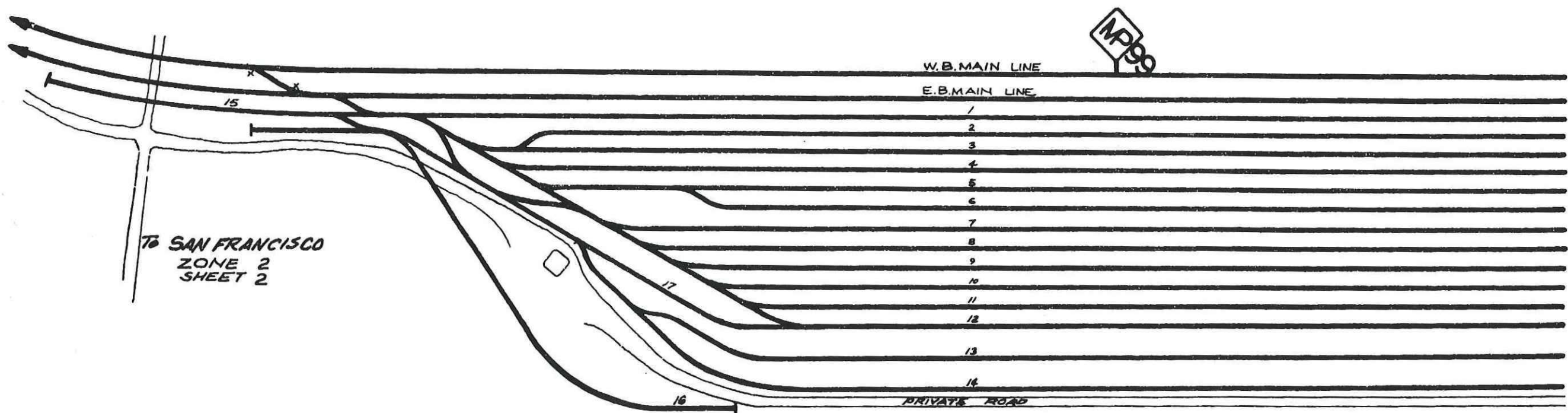

TO SAN FRANCISCO
ZONE 2
SHEET 2

WATSONVILLE JCT.
ZONE 1
SHEET 1
A/R 1973

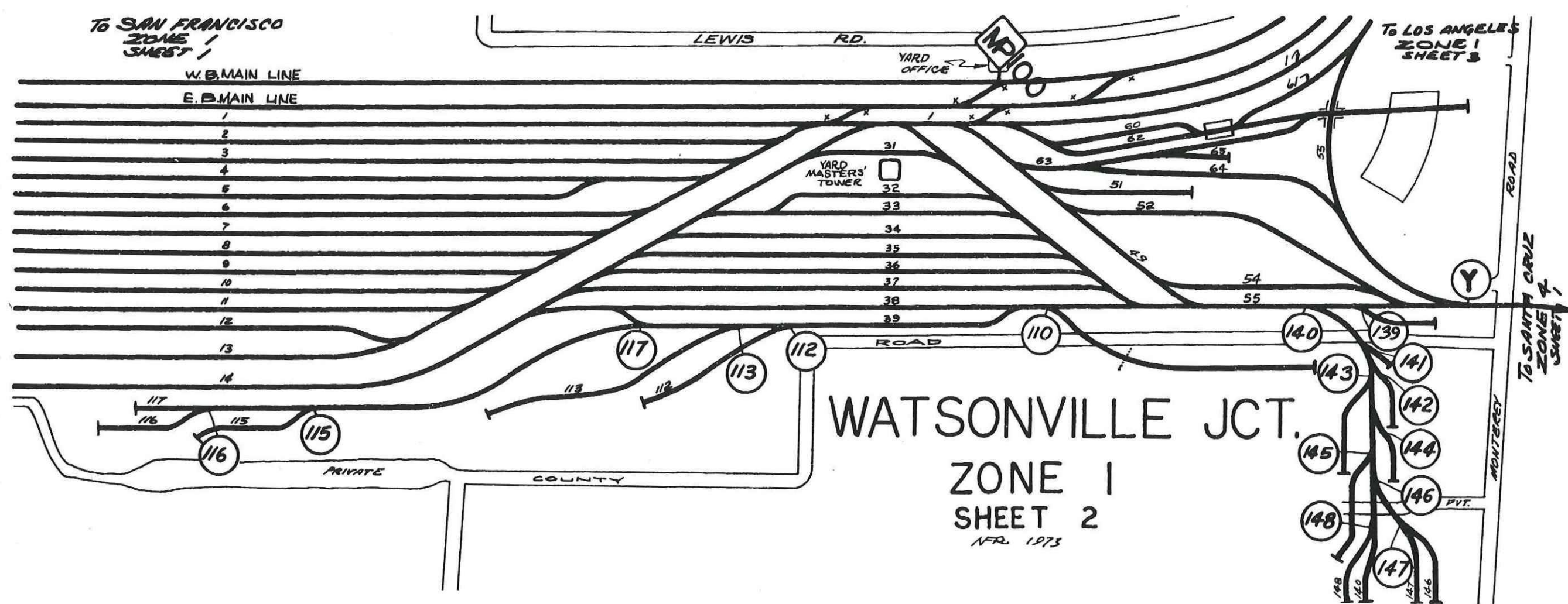

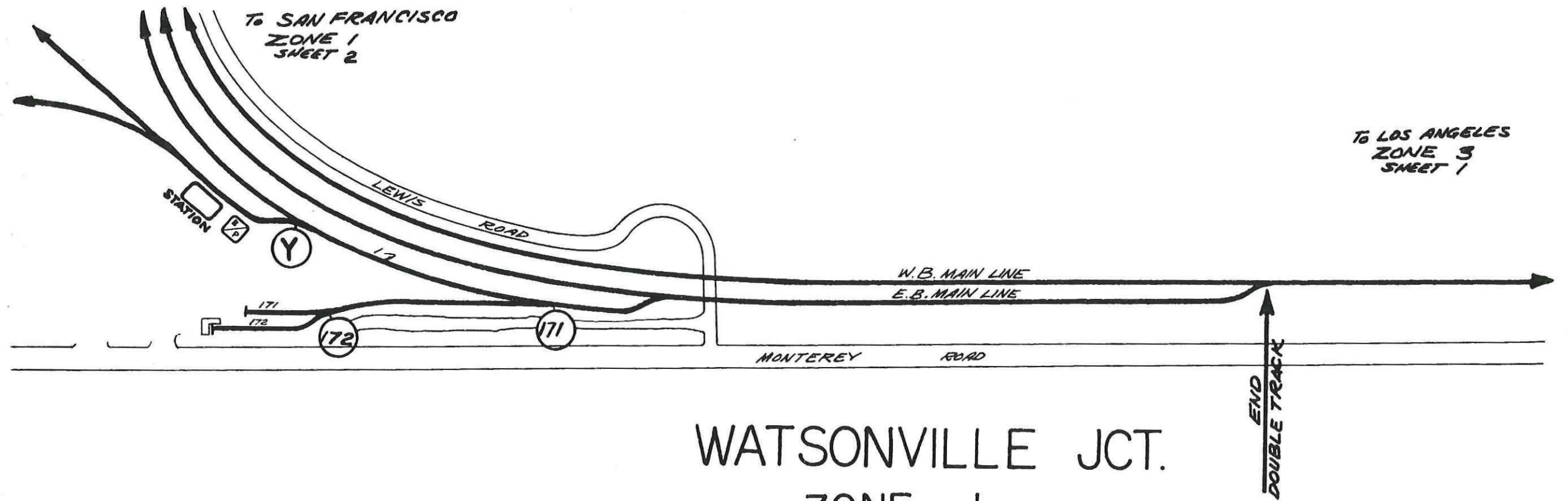

WATSONVILLE JCT.
 ZONE 1
 SHEET 3
 APR 1973

ZONE 2

<u>Track</u>	<u>Industry</u>	<u>Code/Spot</u>
221	Work Lead Track	
223	Union Sugar Beet	94
225	Hillsdale Sand & Gravel	94
240	Interchange Track	91-92
242	Interchange-Storage	91-92
243	Interchange-Storage	91-92
245	Interchange-Storage	91-92
250	Load Track	
250	West Bound Pick-up	92
260	Load Track	
260	East Bound Pick-up	92

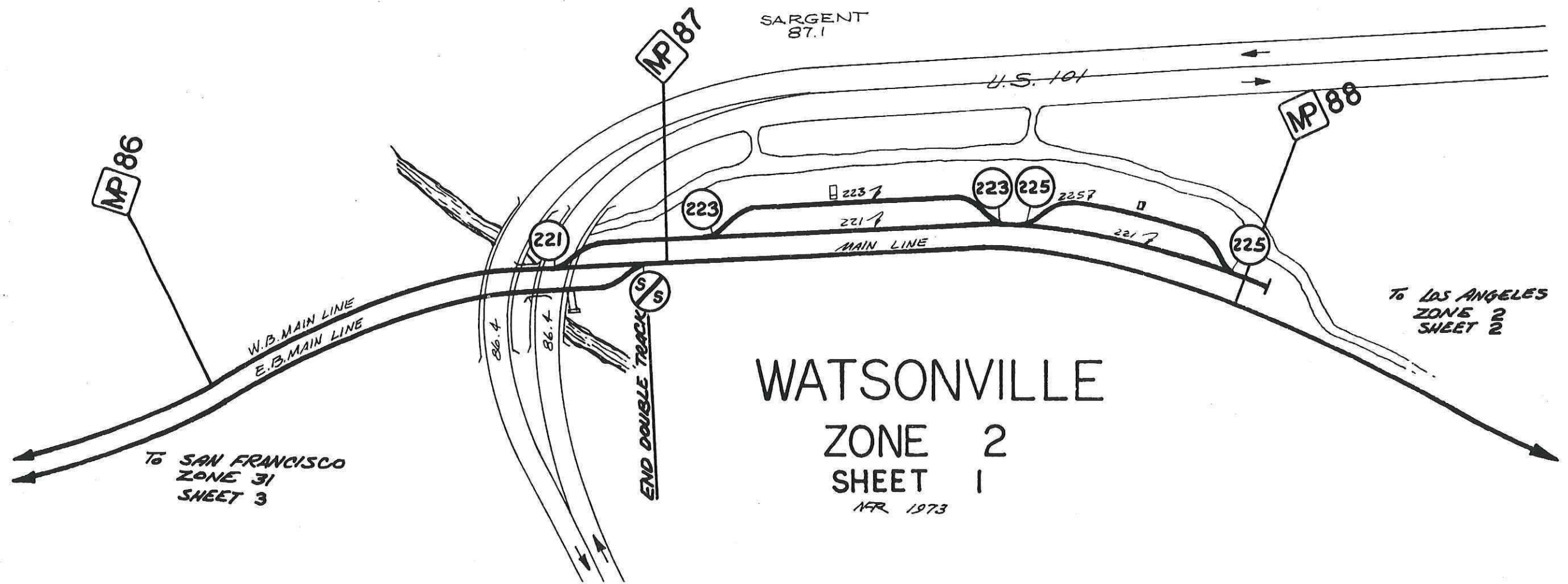

WATSONVILLE

ZONE 2
SHEET 1

APR 1973

MP 86

MP 87

MP 88

SARGENT
87.1

U.S. 101

W.B. MAIN LINE
E.B. MAIN LINE

MAIN LINE

END DOUBLE TRACK
S
S

TO SAN FRANCISCO
ZONE 31
SHEET 3

TO LOS ANGELES
ZONE 2
SHEET 2

WATSONVILLE ZONE 2 SHEET 2

1/17/1973

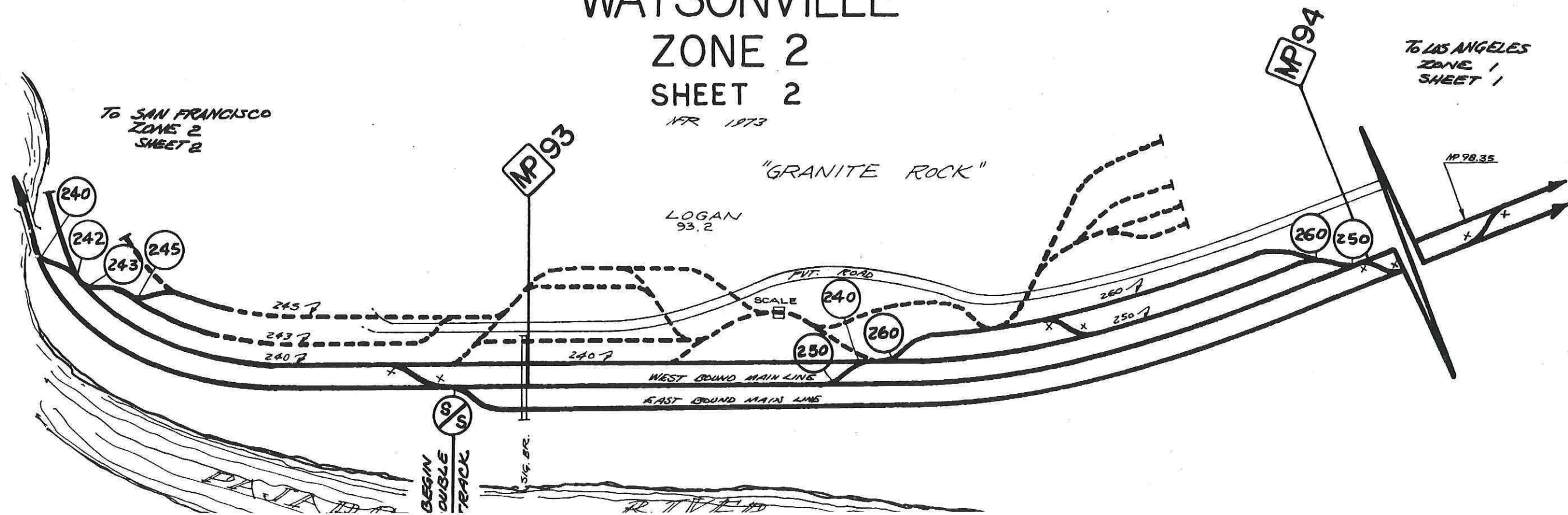

ZONE 3
(Moss Landing)

<u>Track</u>	<u>Industry</u>	<u>Code/Spot</u>
330	Moss Landing Siding	
333	Dolan Road Main	
333	P. G. & E. (end)	99
335	P. G. & E. Lead Track	
335	P. G. & E. (end)	99
337	P. G. & E. Runaround	91
339	Dolan Road Siding	91
341	Lead Track	
341	Seawater #1A (end)	99
343	Seawater #2	99
345	Brick Dock	95 1-7
347	Short Spur	99
349	Seawater #1B	99

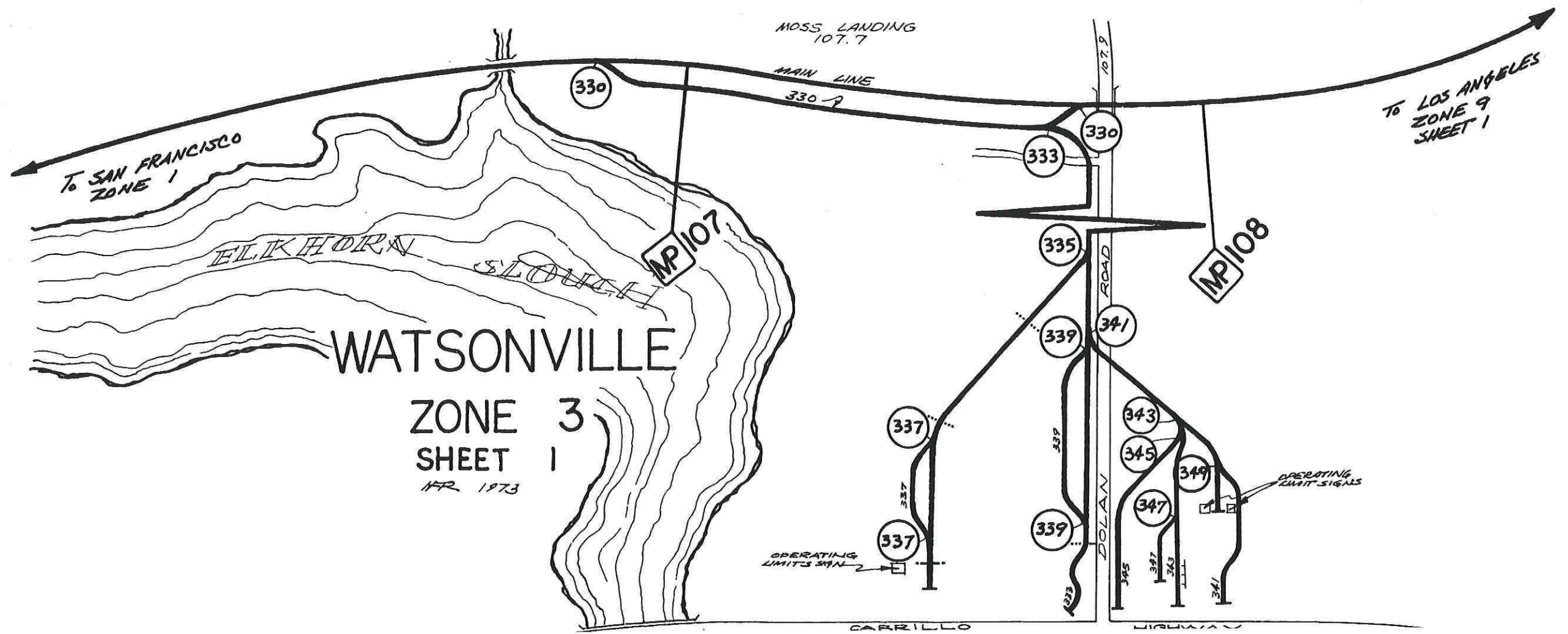

ZONE 4
(Watsonville)

<u>Track</u>	<u>Industry</u>	<u>Code/Spot</u>	<u>Track</u>	<u>Industry</u>	<u>Code/Spot</u>
400	G.P. Martin	1, 2	421	George Barsi	
401	J.M. Bulaich		422	Bachan Fruit Co.	2
402	H.J. Heinz	1, 2, 3, 4	422	Berman Steel	6
403	Speas	1 - 11	422	Sambrillo Paper	12, 13
404	Container Service	99	423	Lead Track	
405	P.V. Cold Storage	4, 5	423	Farmer's Cold Storage	1, 2
406	Gallo Wine	1	423	Watsonville Canning	1, 2
407	Mann-Vallentine Cold Stge.	6	424	Modesko Cold Storage	11, 12
408	Scurich Cold Stge.	1	425	Watsonville Canning	3
409	Neilson Warehouse	3	430	Storage Track	91
410	Buchwald Cold Stge.	1	431	Storage Track	91
411	Calif. Farm Products	99	432	West Coast Farms	
412	West Coast Farms		433	West Coast Farms	1 - 6
413	West Coast Farms		435	Old House Track	91
414	Team Track - Storage	90-91	436	John Inglis	1 - 5
415	Team Track	90	437	Martinelli	8
416	Watsonville Lumber	99	440	Central Supply	99
420	Lead Track		445	Phillips Products	4, 5
420	Lease Plumbing (end)	8			

ZONE 4
(cont'd)

<u>Track</u>	<u>Industry</u>	<u>Code/Spot</u>
450	Lead Track	91
451	Coast Counties Canning	99
451	Travers Cold Storage	99
452	Lead Track	
453	Apple Growers Cold Stge.	
454	Franich	
454	Granite Construction Co.	
455	Green Giant	
456	Coast Counties Canning	
457	Lead for future development	
470	Bud Antle	
471	Bud Antle	
480	Runaround - Storage	91
481	Harris Pine Mills	99
482	Harris Pine Mills	1 - 6
483	Big Creek Lumber	99
490	Mello Cold Storage	6 - 11
490	Del Mar Foods	6 - 11

To WATSONVILLE JCT.
ZONE 1 - SHEET 3

WATSONVILLE JCT.

ZONE 4

SHEET 1

NFR 1973

MP 102

MP 101

To SANTA CRUZ
ZONE 4-SH. 2

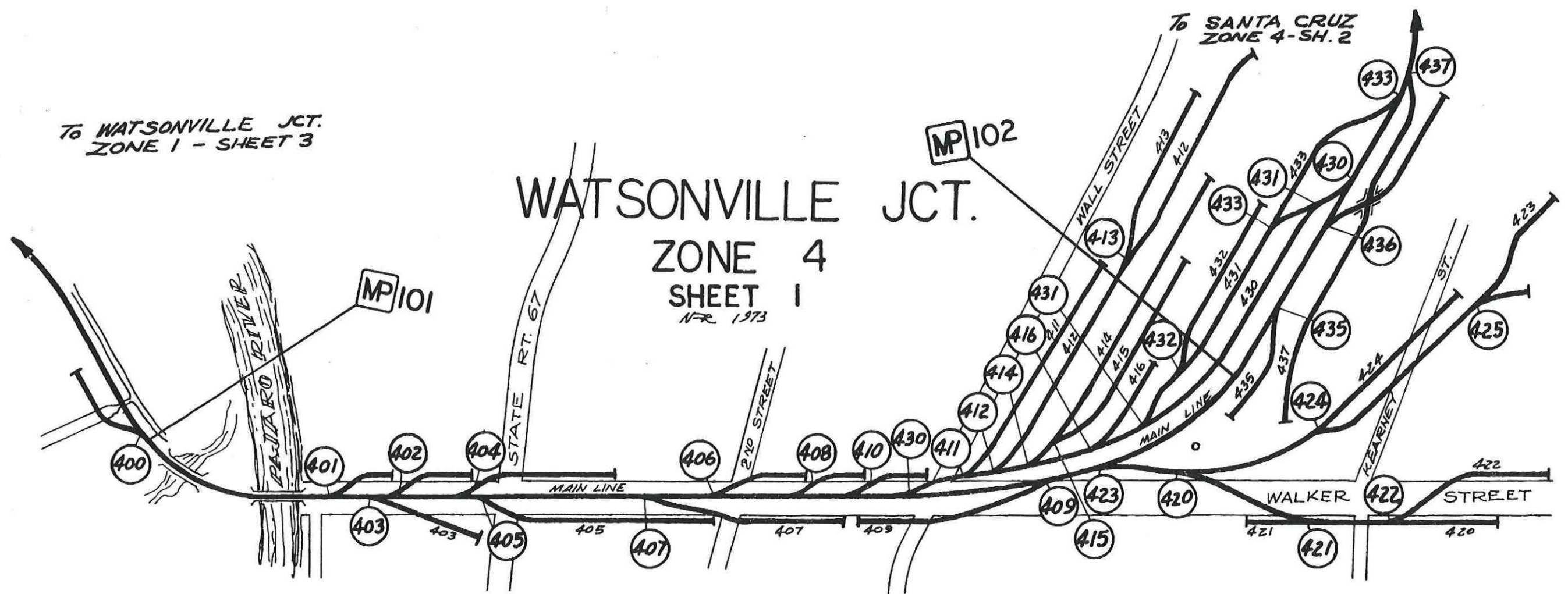

WATSONVILLE JCT.
ZONE 4
SHEET 2
IFR 1973

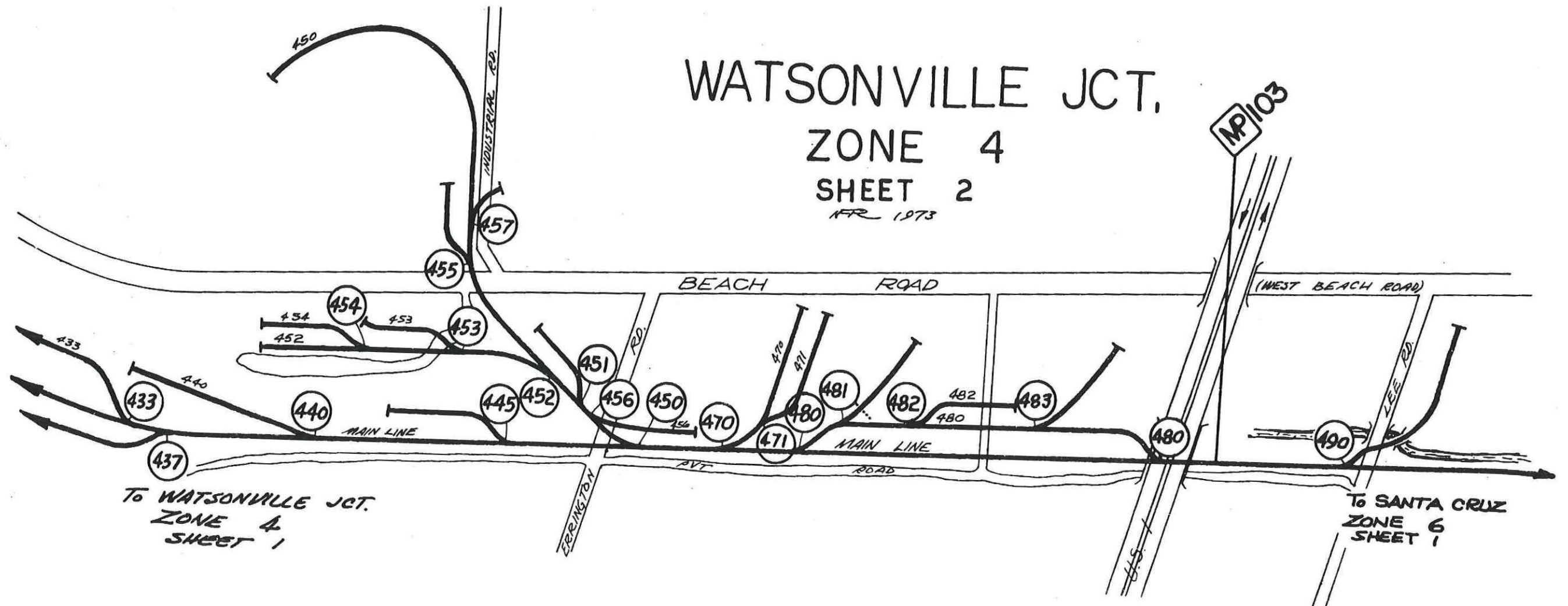

ZONE 6
(Santa Cruz Branch)

<u>Track</u>	<u>Industry</u>	<u>Code/Spot</u>
631	Capitola Team Track	90
637	Ace Lumber	99
637	Holmes	99
637	Standard	99
639	Maywood Mfg.	99
644	Co-Op	1
645	Joseph George	1,2
646	Granite Rock	94
671	Stokely Van Camp	91
673	Stokely Van Camp	95

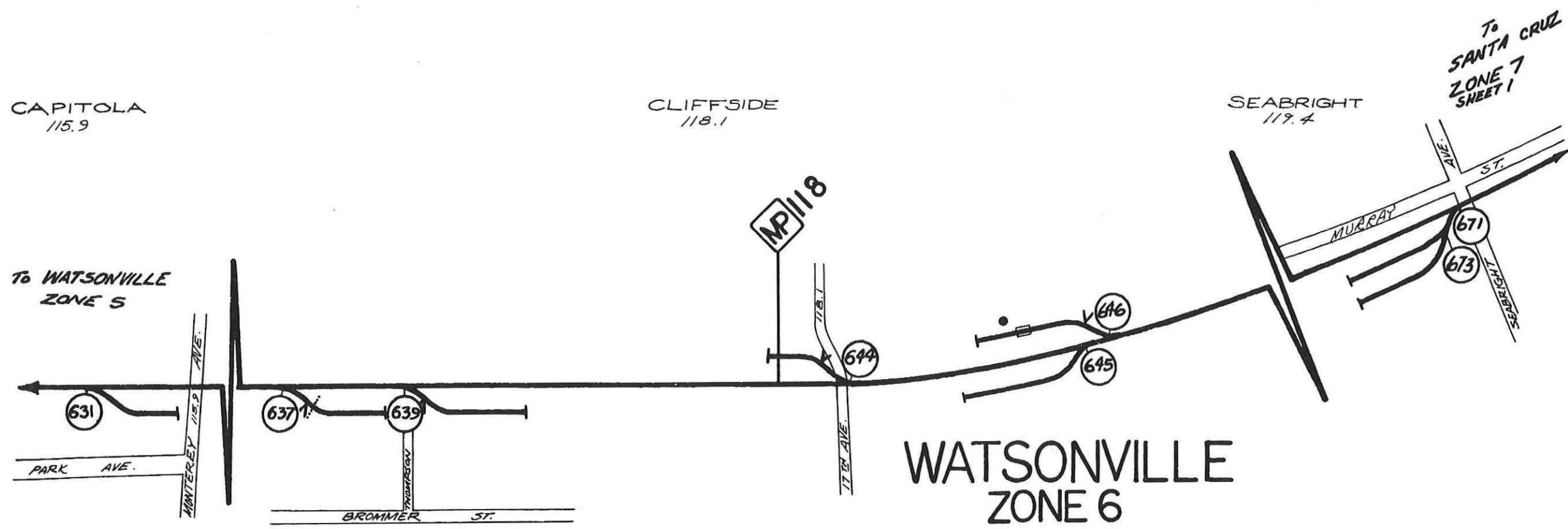

CAPITOLA
115.9

CLIFFSIDE
118.1

SEABRIGHT
119.4

To WATSONVILLE
ZONE 5

To SANTA CRUZ
ZONE 7
SHEET 1

WATSONVILLE
ZONE 6
SHEET 1
NFR 1973

ZONE 7
(Santa Cruz Branch)
(Davenport Branch)

<u>Track</u>	<u>Industry</u>	<u>Code/Spot</u>	<u>Track</u>	<u>Industry</u>	<u>Code/Spot</u>
2	Yard Track	91	791	P C A (Gypsum)	92
3	Yard Track	91	793	P C A (Cement)	92
4	Yard Track	91	795	P C A (Lime Rock)	92
6	Yard Track	91	799	P C A (Storage)	92
707	House Track				
710	Drill Track				
712	John Inglis	95			
715	Team Track	90			
722	Vacant	99			
723	Moceo	99			
724	Birds Eye	95			
726	Santa Cruz Artichoke	95			
729	Mondo	95			
730	Lipton Tea				
731	Pfyffer	95			
733	Wrigley				
735	Runaround				
755	Granite Rock	94			
790	Passing Track				

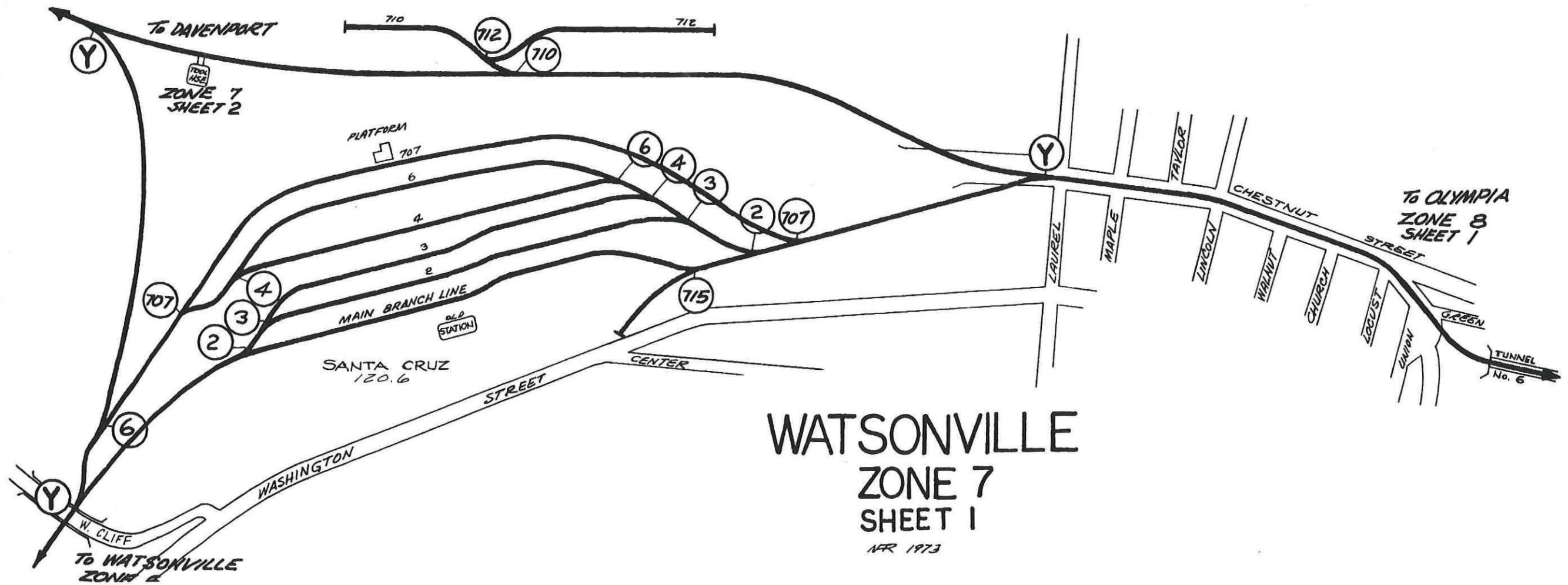

WATSONVILLE
ZONE 7
SHEET 1
NR 1973

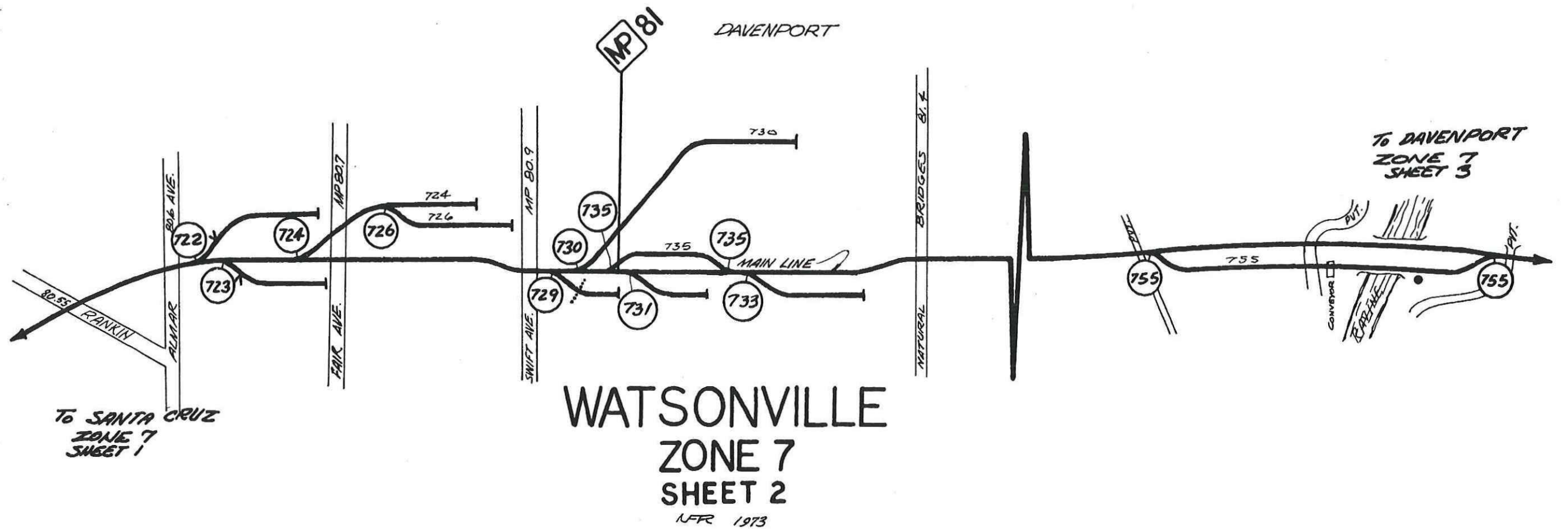

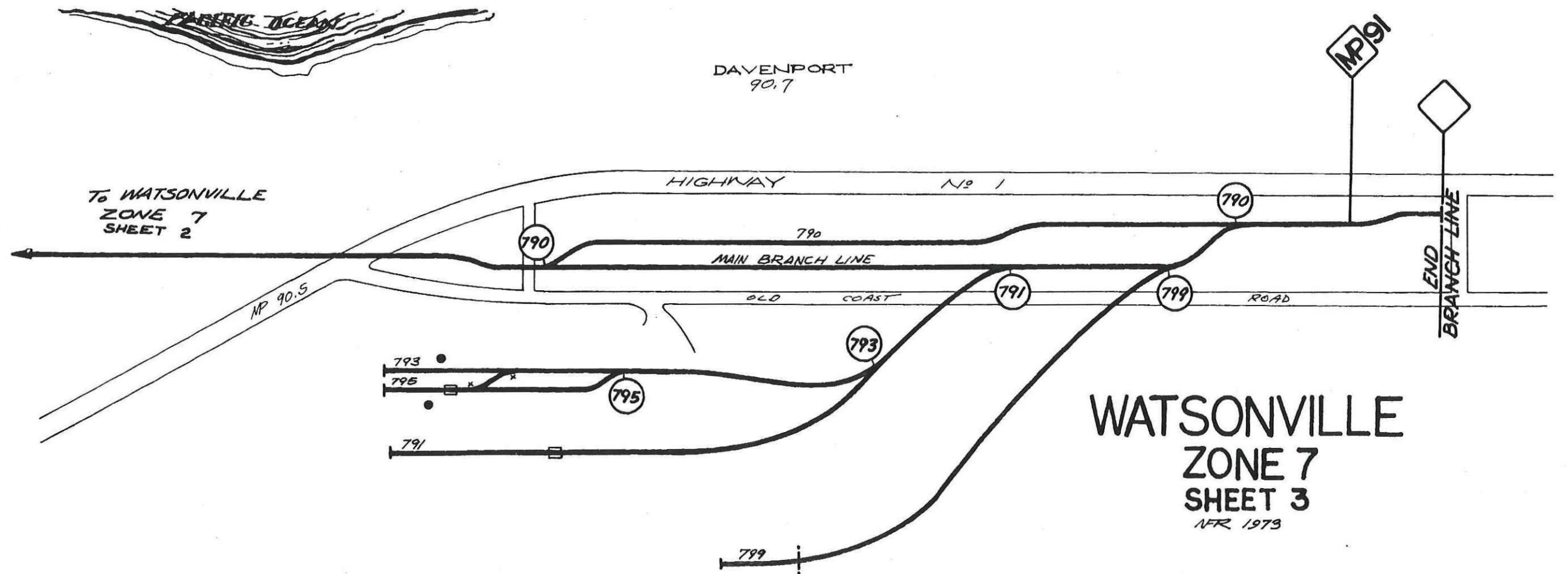

TO WATSONVILLE
ZONE 7
SHEET 2

DAVENPORT
90.7

MP 91

WATSONVILLE
ZONE 7
SHEET 3
NFR 1973

ZONE 8
(Santa Cruz Branch)

<u>Track</u>	<u>Industry</u>	<u>Code/Spot</u>	<u>Track</u>	<u>Industry</u>	<u>Code/Spot</u>
801	Eblis Runaround		899	Sand Spur (Not Used)	94
801	Eblis Team Track	90			
803	Vacant (Spiked)				
805	Vacant (Spiked)				
807	Avex, Inc.	1,2			
809	Sea Berg Metal Fab.	99			
815	Salz Tannery	99			
815	Provenzano Bros.				
	Building Materials	99			
815	Las Animas Concrete	99			
850	Santa Cruz Lumber	99			
851	Passing Track				
853	Roaring Camp Railway	99			
881	P C A (Inbound)	92			
883	P C A	99			
885	P C A (Storage)	91			
889	P C A (Outbound 3)	92			
890	Passing Track				

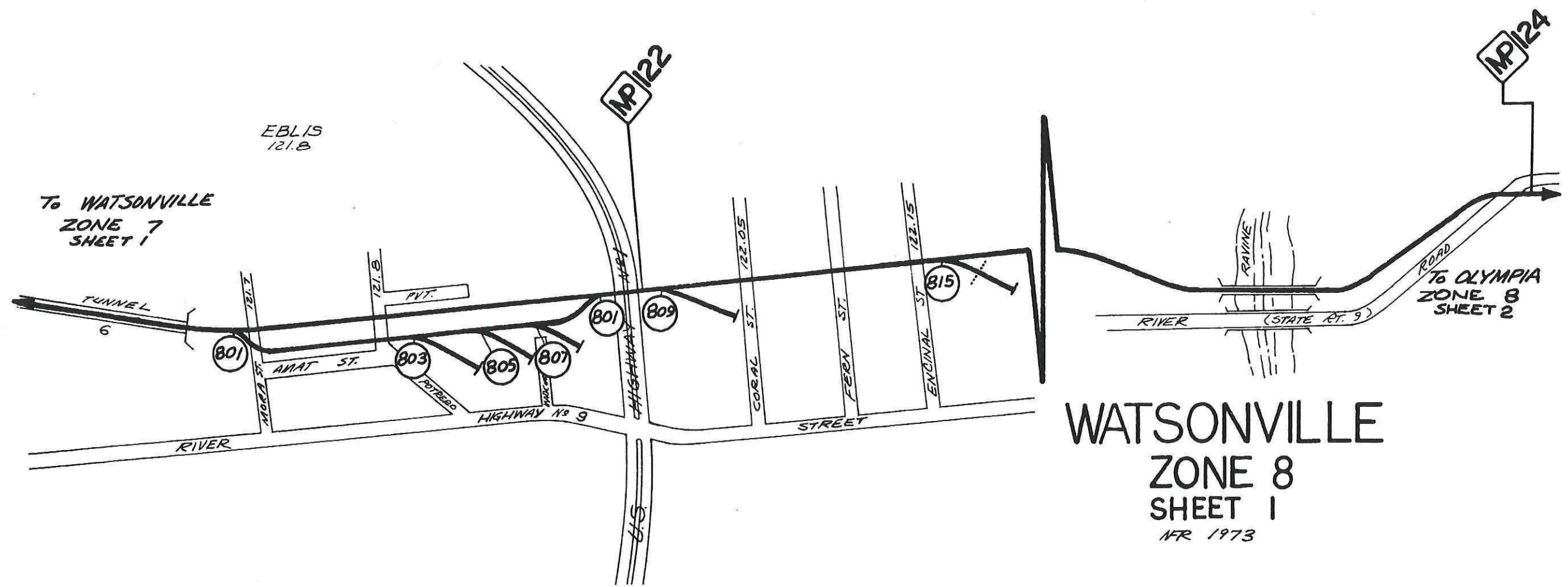

WATSONVILLE
ZONE 8
SHEET 1
NFR 1973

WATSONVILLE ZONE 8 SHEET 2 AFR 1973

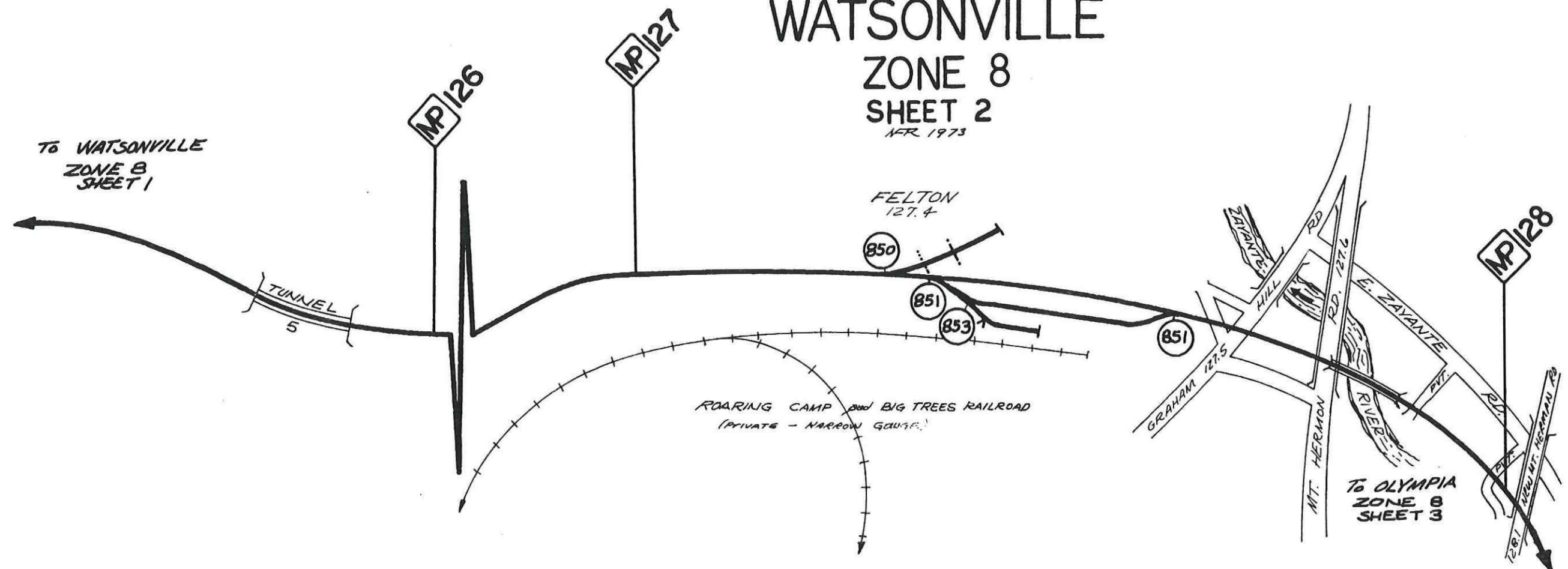

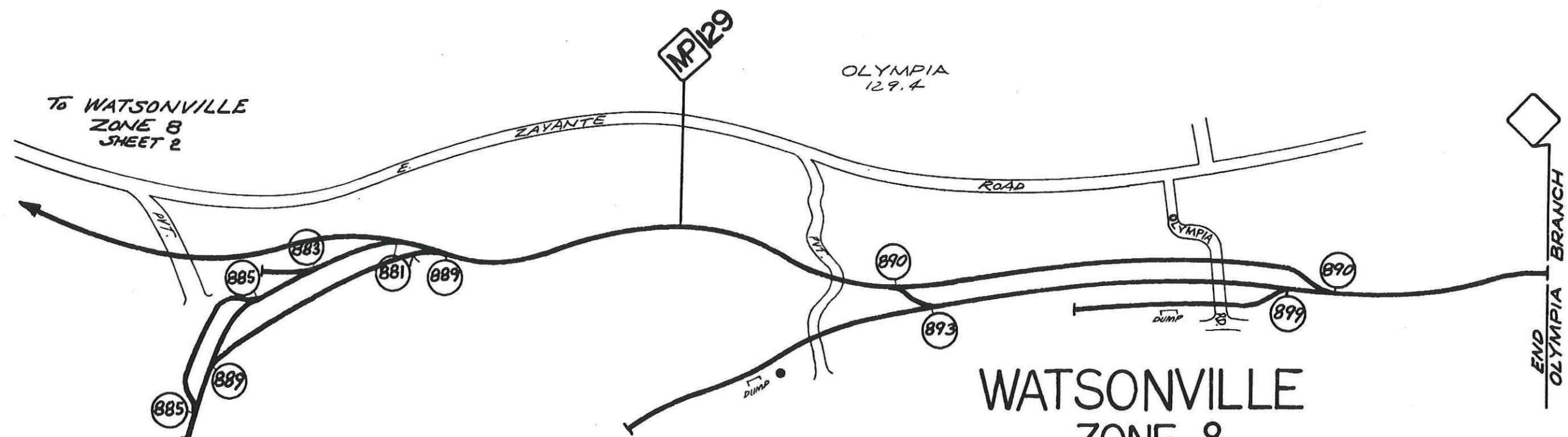

OLYMPIA
129.4

To WATSONVILLE
ZONE 8
SHEET 2

WATSONVILLE
ZONE 8
SHEET 3
NFR 1973

END
OLYMPIA BRANCH

ZONE 9
(Castroville)

<u>Track</u>	<u>Industry</u>	<u>Code/Spot</u>
920	Castroville Siding	
931	Rip Track	99
932	California Artichoke	95
934	Team Track	90
936	Coach Track	91
938	Monterey Bay Pkg.	95
940	Middle Track	
941	Stock Track	99
945	Castroville Mrktg.	95
948	Vacant	99
952	Gene Boggiatto	95
954	D'Arrigo Bros. (New Shed)	95
956	D'Arrigo Bros. (Old Shed)	95
1000	Monterey Main	

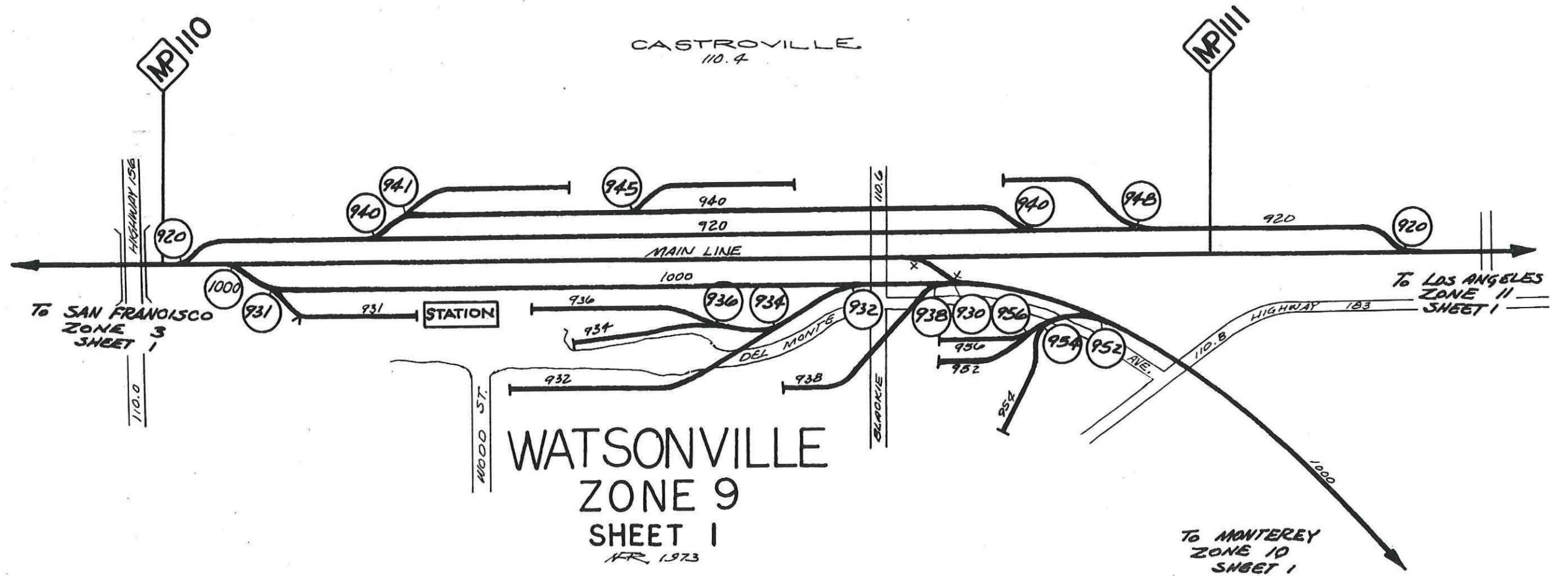

ZONE 10
(Monterey Branch)

<u>Track</u>	<u>Industry</u>	<u>Code/Spot</u>	<u>Track</u>	<u>Industry</u>	<u>Code/Spot</u>
1017	Lone Star Drill Trk.	92	1057	Monterey Fish	95,99
1019	Lone Star Runaround	92	1063	Central Supply	94
1020	Marina Siding		1064	Sparolini Dist.	95
1020	Monterey Sand	94	1066	Central Supply	99
1030	Fort Ord Siding		1067	Bear Transfer	95
1032	Fort Ord Lead Track		1068	Cardinal Van Lines	95
1032	Fort Ord (End)	1 thru 14	1070	Seaside Team Track	90
1033	Fort Ord	99	1075	Monterey Sand	94,95,99
1034	Fort Ord	1 thru 42	1076	Maris Van Lines	95
1036	Fort Ord	1 thru 21	1076	Union Ice	95
1036	Fort Ord (End)	99	1078	Retreat Team Track	90
1037	Fort Ord	1 thru 8	1080	Monterey Siding	
1040	Fort Ord Balloon		1081	American Freezer	95
1043	Fort Ord Balloon #1	97	1083	House Track	95
1045	Fort Ord Balloon #2	97	1085	Team Track	99,90
1052	P.C.A.Prattco	94	1087	Storage Track	91
1053	Granite Const.	94	1089	Ramp	90,97
1055	Dolphin Van & Stg.	95	1092	Team Track	90
1057	Sparolini Dist.	95,99	1094	National Fibre	1 thru 6

ZONE 10
(Monterey Branch)
(Cont'd)

<u>Track</u>	<u>Industry</u>	<u>Code/Spot</u>
1095	Asilomar Team Track	90
1096	Private Car Spur	99
1097	Hayward Lumber	99
1098	Waldron Silica Sand	99
1099	Owen Illinois Glass	94
1000	Waldron Silica Sand (End)	94

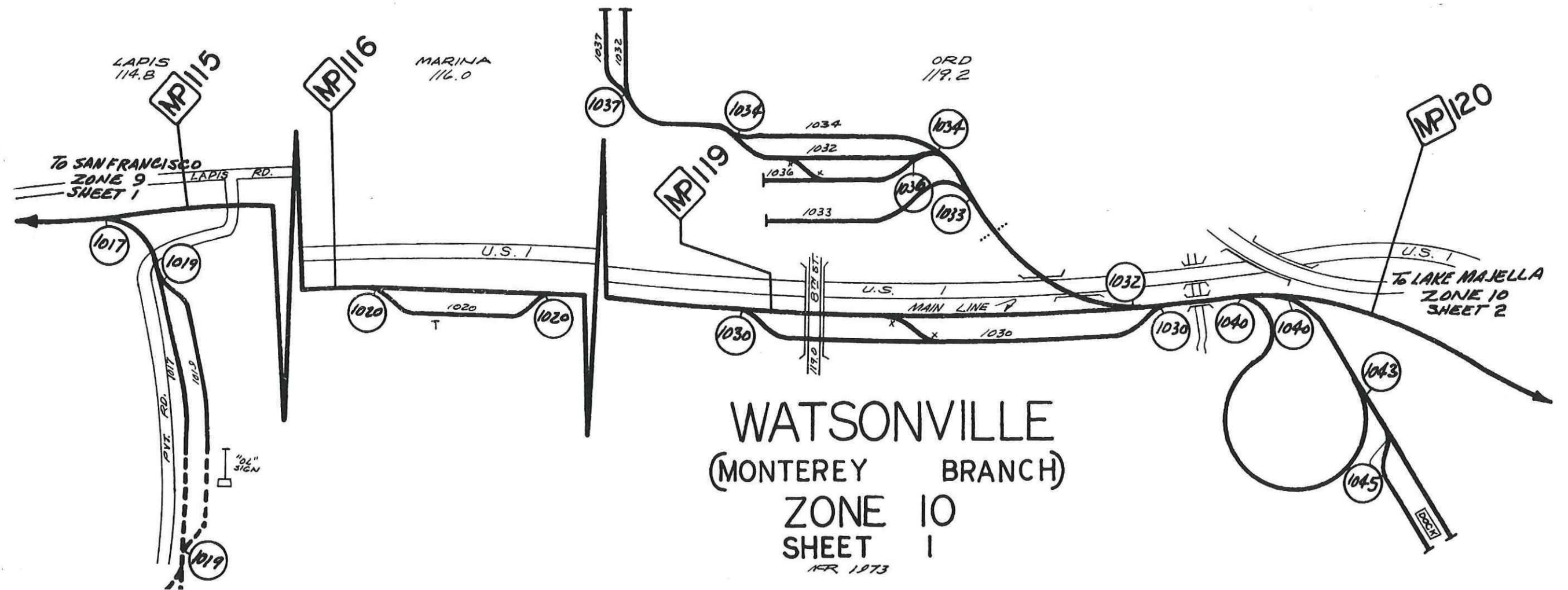

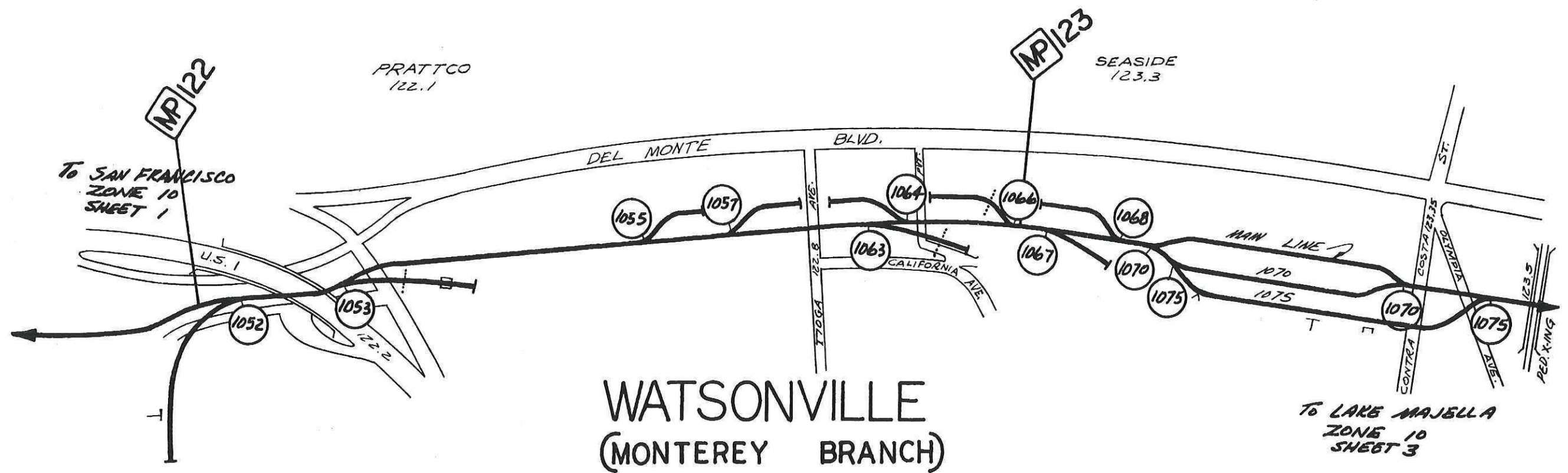

WATSONVILLE
(MONTEREY BRANCH)

ZONE 10
SHEET 2

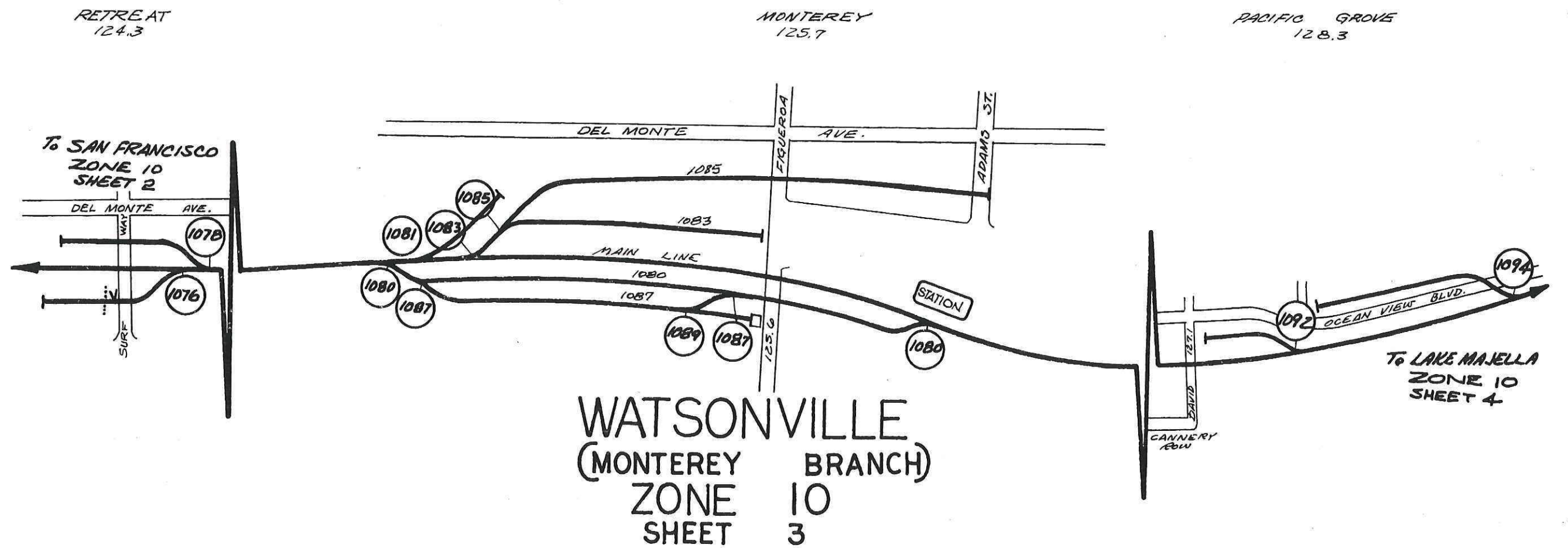

RETRE. AT
124.3

MONTEREY
125.7

PACIFIC GROVE
128.3

TO SAN FRANCISCO
ZONE 10
SHEET 2

DEL MONTE AVE.

WATER
SURF WAY

1078

1076

1081

1083

1085

1080

1087

1089

1087

STATION

1080

WATSONVILLE
(MONTEREY BRANCH)
ZONE 10
SHEET 3

1092

1094

TO LAKE MAJELLA
ZONE 10
SHEET 4

CANNERY RD

DEL MONTE

AVE.

FIGUEROA

ADAMS ST.

1085

1083

MAIN LINE

1080

1087

125.9

127.9

OCEAN VIEW BLVD.

To SAN FRANCISCO
ZONE 10
SHEET 3

WATSONVILLE (MONTEREY BRANCH) ZONE 10 SHEET 4

APR 1973

LAKE MAJELLA
130.0

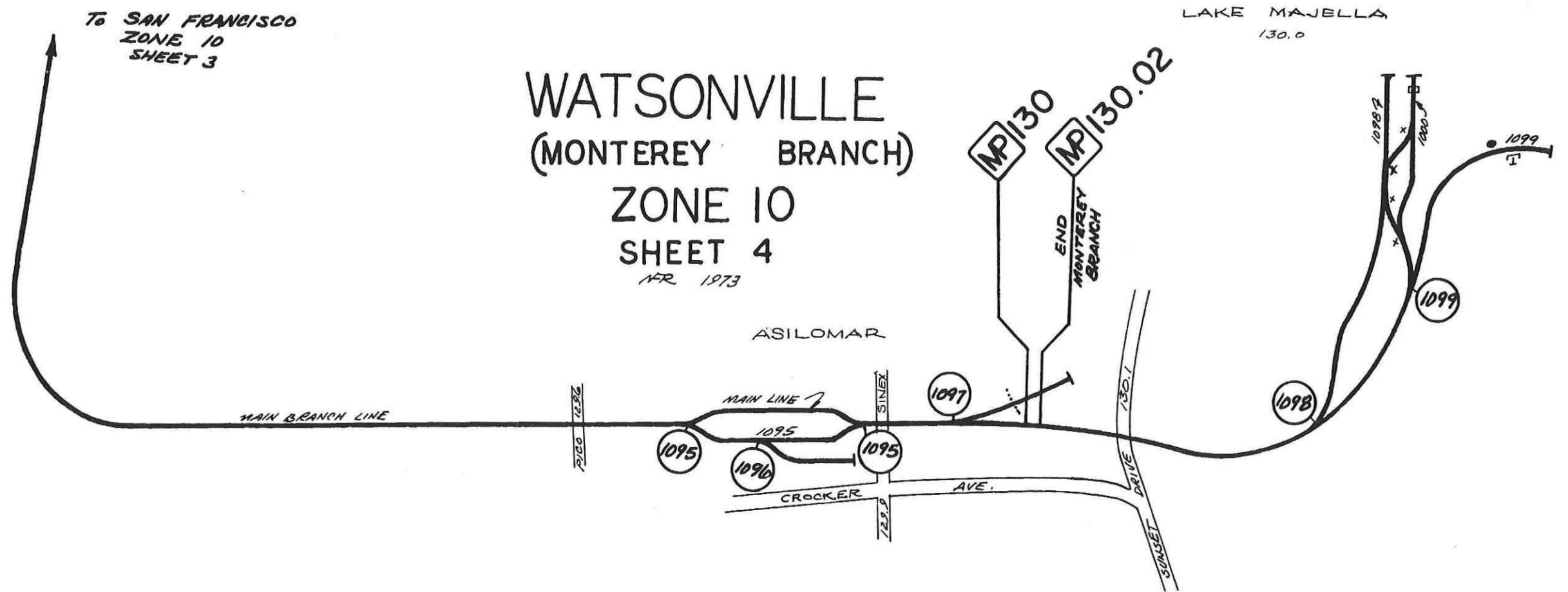

ALPHABETICAL LIST OF INDUSTRIES

<u>Industry</u>	<u>Zone</u>	<u>Track</u>		<u>Industry</u>	<u>Zone</u>	<u>Track</u>	
Admiral	14	1418		Church, Bruce, Co.	15	1502	
Alameda, Robert, Co.	11	1166		City Oil Co.			Team
Alameda Frozen Foods	14	1434		Cochran Equipment Co.			Team
Alisal Freezer	11	1139	Team	Coca Cola Bottling	11	1139	Team
Antle, Bud, Inc. (Mixed Dock)	13	1341		Cominco Products Co.			Team
Antle, Bud, Inc.	13	1328		Consolidated Bag Co.	11	1110	
Antle, Bud, Co. (Cooler)	14	1420		Continental Produce	12	1216	
Associated Chemical	11	1102		Crane Co.	11	1139	Team
Baillie, Jack T., Co.	12	1232		Cragmont Containers Corp. (Hold for Diversions)			
Baillie, Jack T., Co.	13	1309		D'Arrigo Bros.	12	1216	
Belfour Guthrie & Co.			Team	Deans Transfer	11	1139	Team
B & L Produce	15	1513		Delta Growers & Distr.	11	1139	Team
Berman Steel Co.	18	1802		Desert Produce	12	1216	
Cal Pine	14	1418		Eckhart Seed Co.	18	1800	
California Spray Corp.			Team	Emerald Dist. Co.	18	1801	
Canyon Container Corp. (Hold for Diversions)	11			Empire Furniture Co.	11	1139	Team
Central Supply Co.	13	1301		England, C.W. Co.			Team
				Farmers Mercantile	14	1419	

ALPHABETICAL LIST OF INDUSTRIES

(Cont'd)

<u>Industry</u>	<u>Zone</u>	<u>Track</u>		<u>Industry</u>	<u>Zone</u>	<u>Track</u>	
Felix Marsh	13	1332	Team	Growers Ice Dock	15	1512, 1517	
Ferry Morse Seed Co.	11	1139	Team	Hank & Frank	11	1139	Team
Firestone Tire & Rubber Company	16	1640, 1641 1642, 1644 1645, 1646 1647, 1648		Harden Farms	15	1314	
Floor Service Supply Co.	11	1139	Team	Hayward Lumber Co.	14	1406	
Florence Distr.	11	1160		Hoerner Waldorf	15	1540	
Frigi-Vac (Cooler)	14	1410, 1411 1412, 1413		Huddleson			Broker
Frost, C.L. Co.	11	1139	Team	Inter-Harvest	14	1414, 1432 1433	
Gadsby Music Co.	11	1139	Team	Jenkins Lumber Co.	11	1139	Team
Georgia Pacific Corp.	13	1320		Joseph George Distr. Co.	12	1231	
Goodyear Service	11	1139	Team	Jullard Alpha Liquor Co.	11	1139	
Granite Construction	14	1440		Kaiser Alum. & Chem. Corp.	11	1134	
Great A & P Tea Co.	11	1166		Kane & Zech	13	1326	
Griffin Container Co.	13	1332	Team	Kroger Co.			Broker
Growers Cooler	15	1504, 1505 1506, 1507		Kuhlman Electric Co.	13	1323	
				Lapidus			Broker
				Maggio, Carl J., Inc.	13	1312	
				Majestic Furniture Co.	11	1139	Team
				Major Farms			Broker

ALPHABETICAL LIST OF INDUSTRIES

(Cont'd)

<u>Industry</u>	<u>Zone</u>	<u>Track</u>	<u>Industry</u>	<u>Zone</u>	<u>Track</u>
Mann Packing Co.	14	1445	Monterey County Linoleum		
Markham W.		Broker	& Carpet	11	1139 Team
Martin Bros. Container	14	1403	Monterey County Liquor	11	1139 Team
Martin Products	15	1523	Monterey County Yard	13	1301
Maytag Sales & Service	11	1139 Team	Mutual Sales		Broker
McMahan Furniture	11	1139 Team	Nestles Co., The	15	1544, 1546
Merchants Refrigeration	14	1434	N H 3 Service	11	1139 Team
Merit Packing Co.	13	1308	Olsen Van Lines	11	1139 Team
Merrill Farms	15	1524	Oshita Inc.	11	1162
Metzger Box Co.	11	1139 Team	Oshita	12	1209
Mid Coast	12	1216	Pacific Fruit & Prod.	12	1210, 1212
Mills Bros. Distr. Co.	13	1303	Pacific Motor Trucking	12	1240
Mitchell Silliman Co.	14	1446	Pacific Telephone Co.	13	1325
Mitchell Silliman Co.	11	1110, 1142	Packwoods	11	1139 Team
		1146	Peninsula	11	1139 Team
Monte Mart	13	1322	Pepsi Cola Bottling	11	1139 Team
Monterey Bay Suppliers	11	1139 Team	Peter Paul	16	1622, 1623
Monterey County Box	13	1331	P.G. & E.	11	1139 Team
Monterey County Ice	14	1415, 1416	Pic & Pac	14	1436, 1437
		1417			

ALPHABETICAL LIST OF INDUSTRIES

(Cont'd)

<u>Industry</u>	<u>Zone</u>	<u>Track</u>	<u>Industry</u>	<u>Zone</u>	<u>Track</u>
Piggy-Back Ramp	11	1124 thru 1130	Salinas Tallow Co.	11	1139
Piggy-Back Storage	11	1120, 1122	Salinas Valley Appliance/12		1230 Team
Poleon	13	1327	Salinas Valley Wax Paper/14		1438
Pringle Tractor Co.	14	1404 Team	Schilling Co.	13	1350
Pur-Gro	12	1232 Team	Schumann Farms	12	1216
Quinn Co.	12	1242	Scotts Van & Storage	13	1332 Team
Rays Transfer & Stg.	11	1139 Team	Sears Roebuck	13	1324
Richardson Motor Co.	12	1242 Team	Shippers Ice & Dev.Co.	13	1304, 1305
R & M Produce Co.	12	1230	Slone, J.F. Co.	13	1335
Rosoffs Furniture Co.	11	1139 Team	Smucker, J.M. Co.	13	1343
Rossi Distr. Co.	15	1551, 1552	Soil Service	14	1447
Russ Hale Roofing	11	1139 Team	Spiegl Farms	14	1444
Salinas Bean Co.	18	1800	Spreckels Sugar Co.	17	All 1700 tracks
Salinas Cool	11	1164	Standard Furniture Co.	11	1139 Team
Salinas Feed & Seed Co.	11	1144	Stewart Packing Co.	15	1511
Salinas Maytag Sales	11	1139 Team	Stone, E.B. Co.	18	1802
Salinas Lettuce Farmers Co-Op	13	1311	Streaters Industries	13	1345
Salinas Marketing Co-Op	15	1518, 1541	Sunnyside Nursery	11	1139 Team

ALPHABETICAL LIST OF INDUSTRIES

(Cont'd)

<u>Industry</u>	<u>Zone</u>	<u>Track</u>	
Tay Holbrook Co.	11	1139	Team
Tri Counties Packing	13	1312	
Tynan Lumber Co.	14	1401	
Uni-Kool(Union Ice Co.)	12	1201, 1202 1204, 1205 1214, 1216	
Union Sugar Co.	11	1101	
United States Plywood Co.	13	1332	Team
Unidynamics	11	1139	Team
Valley Cooling Co.	13	1333, 1334	
Van Gas Co.	11	1139	Team
Walter S. Markham			Broker
Vegetable Growers Supp.	15	1504, 1542	
Veg Pak	15	1522	
Weber Equipment Co.	12	1242	Team
Western Plumbing Co.	11	1139	
White Tractor Co.	12	1242	Team
Wickes Lumber	15	1550	

ZONE 11

Track	Industry	Code/Spot
1	Yard Track	91
3	Yard Track	91
5	Yard Track	91
7	Yard Track	91
9	Yard Track	91
11	Yard Track	91
15	Yard Track	91
1100	Cooper Siding	91
1101	Union Sugar	94,99
1102	Associated Chemical	1,2
1103	Drill Track	91
1110	Consolidated Bag	99 1,2,3
1110	Mitchell Silliman Co.	99
1120	Yard-Storage	91
1122	Yard-Storage	91
1124	Trailer-Flatcar Ramp	97
1126	Trailer-Flatcar Ramp	97
1128	Trailer-Flatcar Ramp	97
1130	Trailer-Flatcar Ramp	97

Track	Industry	Code/Spot
1132	Yard Track-Runaround	91
1134	Kaiser Alum.&Chem.	95,99 1-10
1137	Engine Spur	91
1138	Oil & Sand Spur	91
1139	Team Track	90
1139	Western Plumbing Co.	99 1
1142	Mitchell Silliman Co.	1-5
1144	Salinas Feed & Seed Co.	1,2,3
1146	Mitchell Silliman Co.	99 4,5
1150	Lead Track	91
1154	Vacant	99
1160	Lead Track	91
1160	Florence Distributors	99
1161	Vacant	99
1162	Oshita, Inc.	95 1,2,3
1163	Lead Track	91
1164	Salinas Cool	99
1165	Storage Track	91
1166	The Great A&P Tea Co.	95 1-6
1166	Robert Alameda Co.	95 1-6

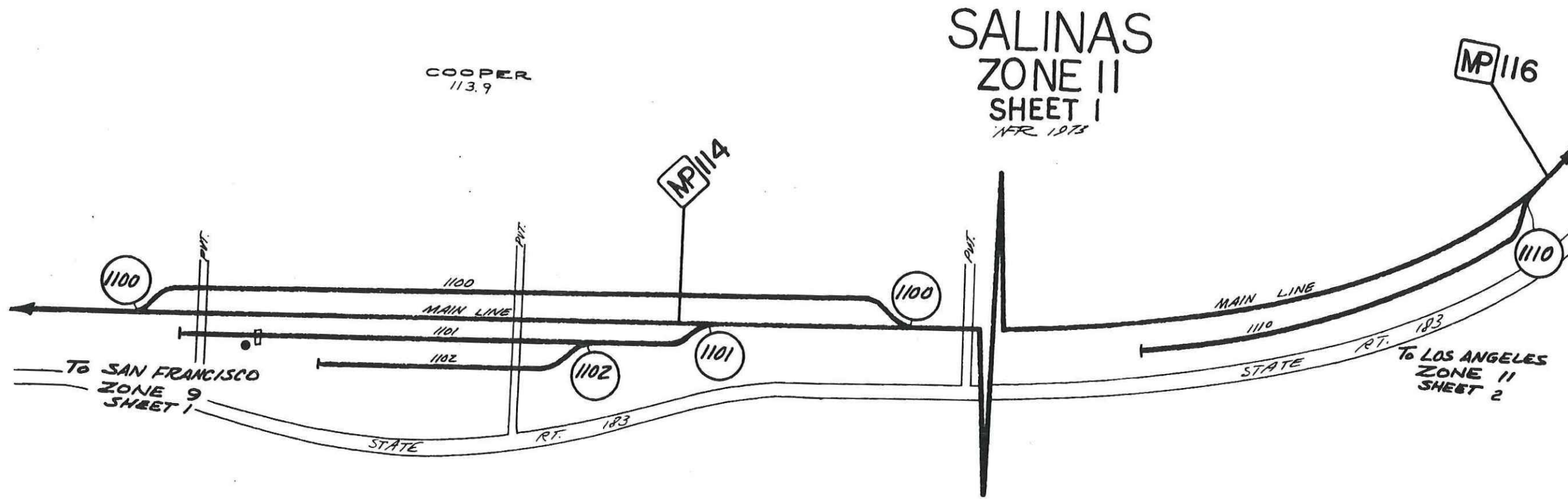

SALINAS
ZONE II
SHEET I
APR 1973

COOPER
113.9

MP 116

MP 114

1100

1100

1100

1110

1102

1101

To SAN FRANCISCO
ZONE 9
SHEET 1

To LOS ANGELES
ZONE 11
SHEET 2

STATE

RT. 183

STATE

RT. 183

MAIN LINE

MAIN LINE

PVT.

PVT.

PVT.

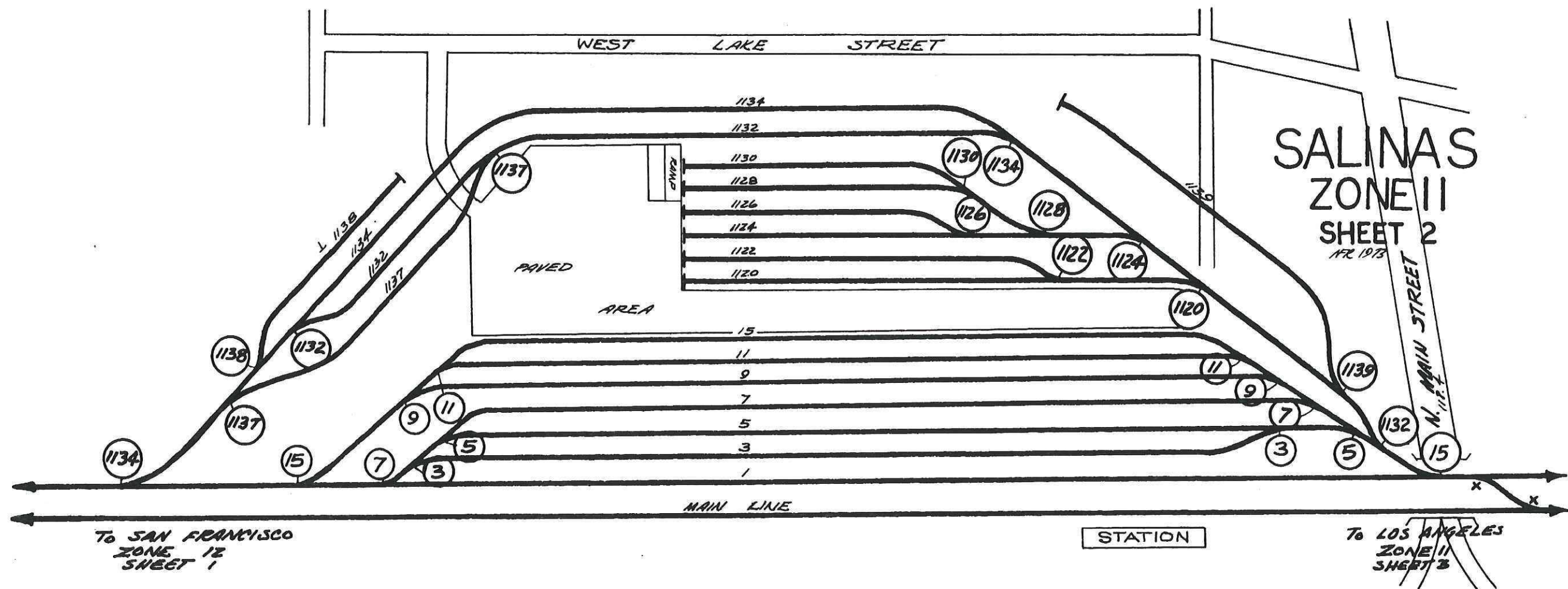

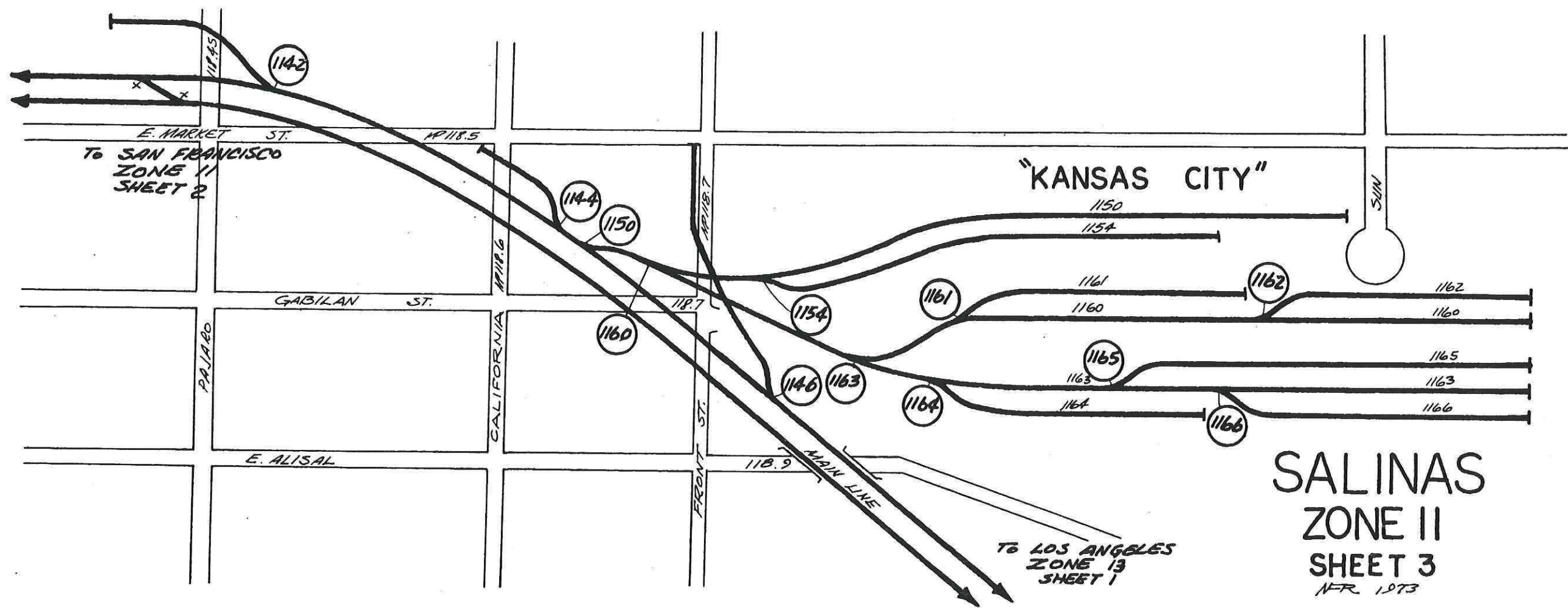

ZONE 12

<u>Track</u>	<u>Industry</u>	<u>Code/Spot</u>
1200	Storage Track	91
1201	Uni-Kool Ice Co.(Union)	95
1202	Uni-Kool Ice Co.	95
1203	Lead Track	91
1204	Uni-Kool Ice Co.(Union) (Vacuum Tube)	99
1205	Uni-Kool Ice Co.(Union)	91
1207	Out of Service	99 1-6
1208	Lead Track	91
1209	Oshita, Inc.	95 1-5
1210	Pacific Fruit & Produce	95 1-6
1212	Pacific Fruit & Produce	95 1-3
1214	Uni-Kool Ice Co.(Union)	95,99 1-4
1216	Uni-Kool Ice Co.(Union)	95 1-10
1216	Mid Coast	95
1216	D'Arrigo	95
1216	Desert Produce	95
1216	Schumann Farms	95
1216	Continental Produce	95

<u>Track</u>	<u>Industry</u>	<u>Code/Spot</u>
1230	Lead Track	91
1230	Team Track	90,95 1,2,3,4
1230	R & M Produce	2-16
1230	Salinas Valley Appliance	2
1231	Joseph George Distr.	1,2
1232	Pur-Gro.	95 1,2
1232	Jack T. Baillie	95 1,2
1234	Vacant	
1240	PMT	95 1-5
1242	Team Track	90,97

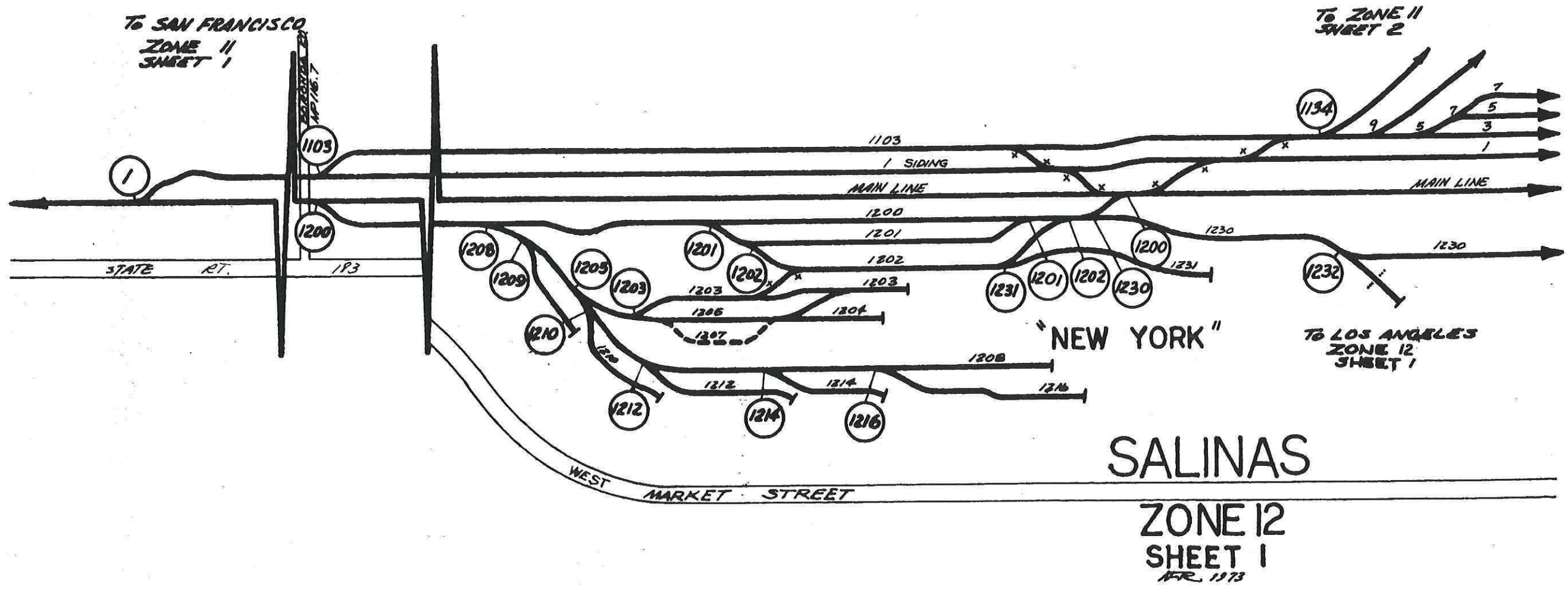

To SAN FRANCISCO
 ZONE 11
 SHEET 1

To ZONE 11
 SHEET 2

STATE RT.

193

"NEW YORK"

To LOS ANGELES
 ZONE 12
 SHEET 1

SALINAS

ZONE 12
 SHEET 1
 FEB. 1973

WEST MARKET STREET

SALINAS
ZONE 12
SHEET 2
NFR 1978

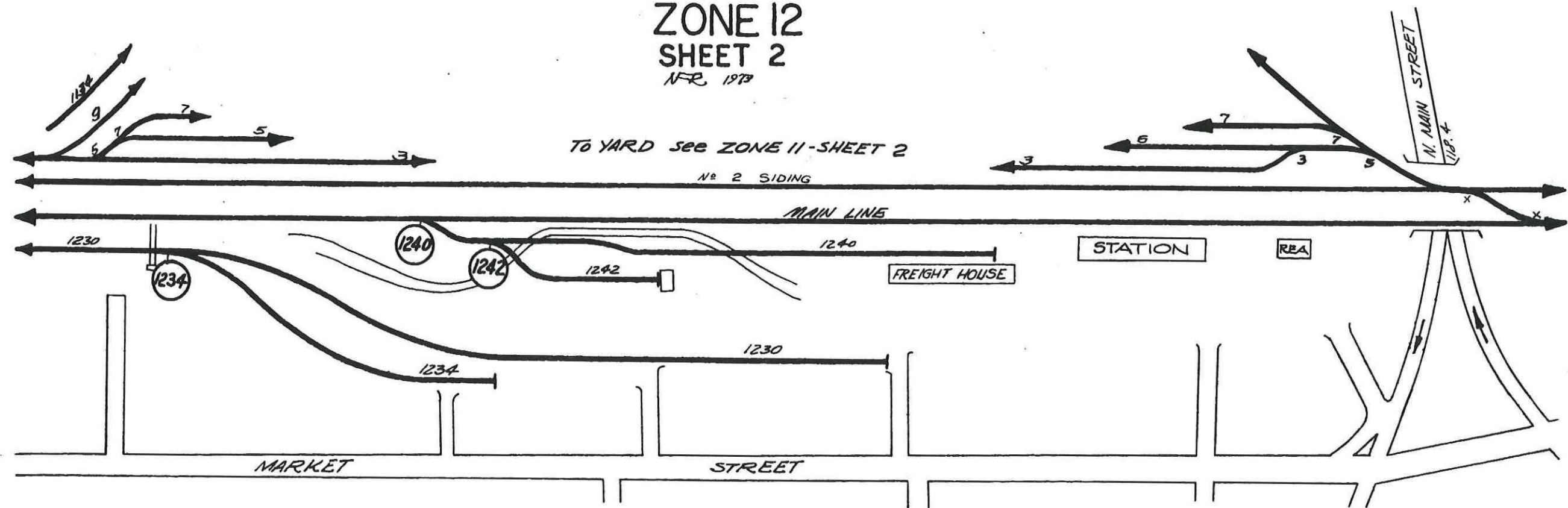

ZONE 13

Track	Industry	Code/Spot
1300	Drill Track	
1301	Central Supply Co.	99
1301	Monterey County Yard	99
1302	Lead Track	91
1303	Mills Bros. Distr.Co.	95 1-8
1304	Shippers Develop. Co.	95 1-8
1305	Shippers Develop. Co.	95 1-8
1306	Lead Track	91
1307	Storage Track	91
1308	Merit Packing Co.	95 1-8
1309	Jack T. Baillie	95 1-6
1310	Vacant	91
1311	Salinas Lettuce Farmers Co-Op	95 1-8
1312	Tri Counties Packing	95 1,2
1312	Carl Maggio, Inc.	95 3-8
1313	Vacant	99
1320	Georgia Pacific Corp.	95 1,2
1321	Lead Track	91

Track	Industry	Code/Spot
1322	Monte Mart	99 1,2
1323	Kuhlman Electric Co.	95 1
1324	Sears Roebuck Co.	1
1325	Pacific Telephone	99 1,2
1326	Kane & Zech	1
1327	Poleon	1
1328	Bud Antle Co.	99
1330	Lead Track	91
1331	Monterey County Box	99
1332	Team Track	90,95,99/1
1333	Valley Kool Co.	95 1-8
1334	Valley Kool Co.	95 1-8
1335	J.F. Slone Co.	99 1,2
1340	Lead Track	91
1341	Bud Antle Co.	95 1-6
1343	The Smucker Co.	95 1-4
1345	Streaters Industries, Inc.	1,2
1350	Schilling	1,2

SALINAS
ZONE 13
SHEET 1
APR 1913

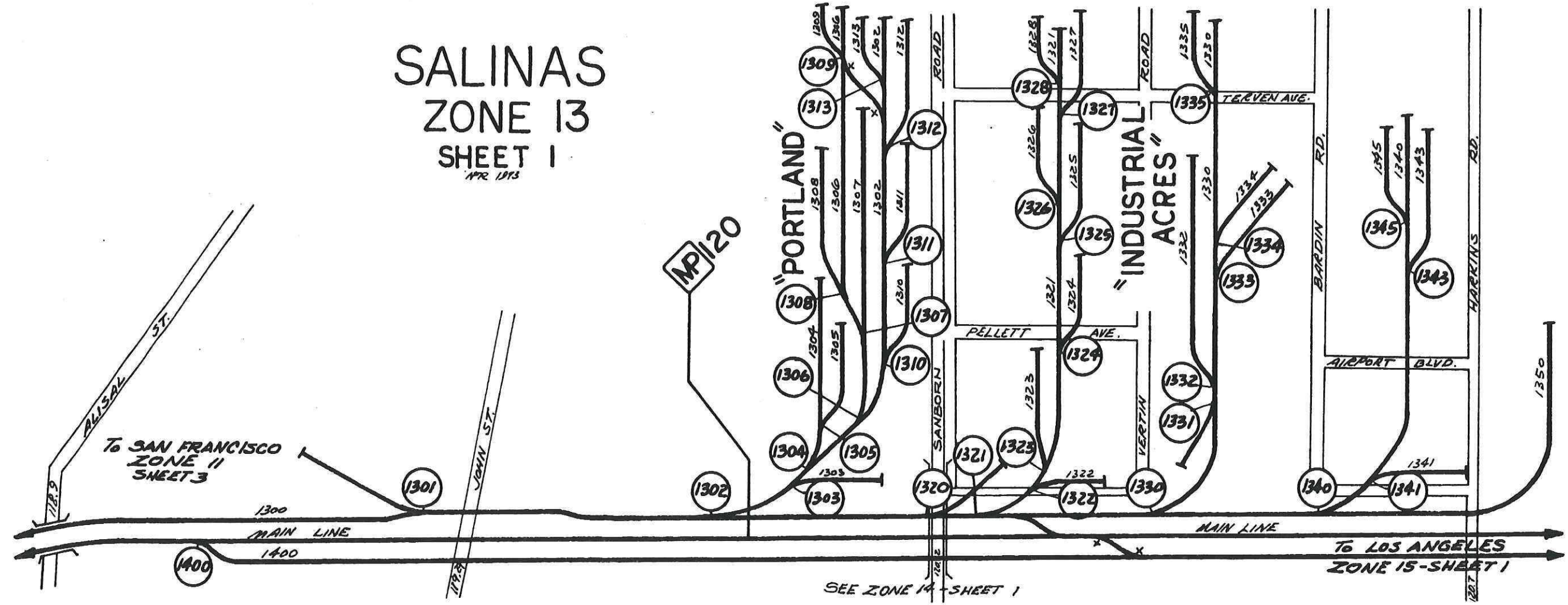

ZONE 14

Track	Industry	Code/Spot
1400	Lead Track	
	Chicago-Alisal Long	91
1401	Tynan Lumber Co.	99 1-3
1402	Lead Track	91
1403	Martin Bros. Container	95 1-6
1404	Pringle Tractor Co.	95 1
1406	Homer T. Hayward Lmbr.	99
1407	Vacant	99
1408	Storage Track	91
1410	Frigi-Vac	99 1-16
1411	Frigi-Vac	99 1-16
1412	Frigi-Vac	99 1-16
1413	Frigi-Vac	99,95/1-8
1414	Inter-Harvest	99,95/1-11
1415	Monterey County Ice	99,95/1-8
1416	Monterey County Ice	99,95/1-8
1417	Monterey County Ice	99,95/1-8
1418	Admiral	95 1-5
1418	Cal Pine	99 1-4

Track	Industry	Code/Spot
1419	Farmers Merchantile Co.	97 5
1420	Bud Antle Co.	99,95/1-10
1432	Inter-Harvest	99,95/1-7
1433	Inter-Harvest	99,95/1-7
1434	Merchants Refrigeration	99 1-10
1434	Alameda Frozen Foods	99 1-9
1435	Storage Track	91
1436	Pic & Pac	95 1-4
1437	Pic & Pac	95 1-4
1438	Salinas Valley Wax Paper Co.	1-5
1440	Granite Construction	99
1442	Vacant	99
1444	Spiegl Farms, Inc.	99,95/1-8
1445	Mann Packing Co.	99,95/1-11
1446	Mitchell Silliman	1-12
1447	Soil Service, Inc.	99 1,2
1450	Spreckels Siding	91

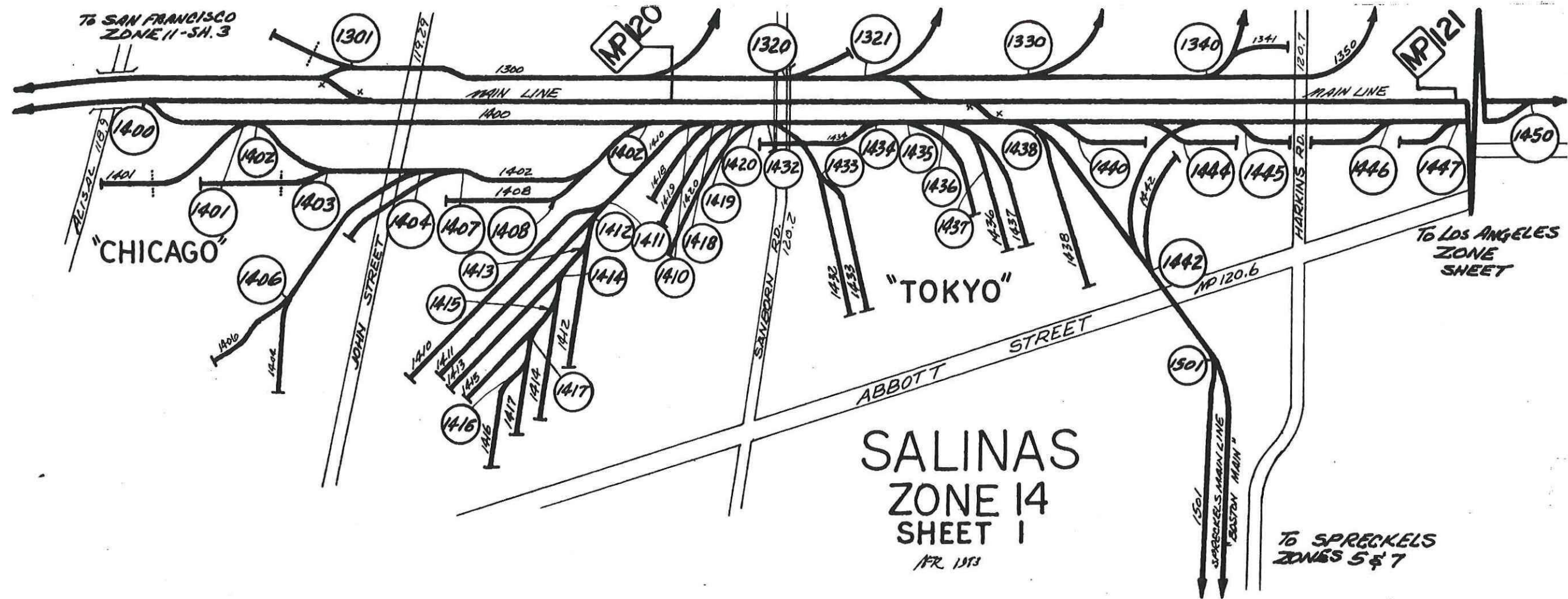

ZONE 15

Track	Industry	Code/Spot
1500	Boston Main	
1501	Boston Lead	91
1502	Bruce Church	99 1-7
1503	Vacant	99
1504	Vegetable Growers Supply	99 3-5
1504	Growers Kool	95 6-13
1505	Growers Kool	95 1-6
1506	Growers Kool	95 1-13
1507	Growers Kool	95 1-6
1511	Stewart Packing Co.	95 1-10
1512	Lead Track	91
1512	Growers Ice Dock(end)	95 1-20
1513	B & L Produce	95 1-7
1514	Harden Farms	95 1-7
1515	Storage Track	91
1516	Storage Track	91
1517	Growers Ice	95 1-20
1518	Salinas Marketing Assn.	95 1,2

Track	Industry	Code/Spot
1519	Storage Track	91
1520	Storage Track	91
1521	Lead Track-Storage	91
1522	Veg Pak	95 1-7
1523	Martin Products	95 1-6
1524	Merrill Farms	95 1-5
1540	Lead Track	91
1540	Hoerner Waldorf (end)	95 1-7
1541	Salinas Marketing Co-Op	95 1-6
1542	Vegetable Growers Supp.	99
1544	Nestles	1-7
1546	Nestles	99 1-10
1550	Wickes Lumber	99
1551	Rossi Distributors	95
1552	Rossi Distributors	99,91
1553	Proposed Spur	99

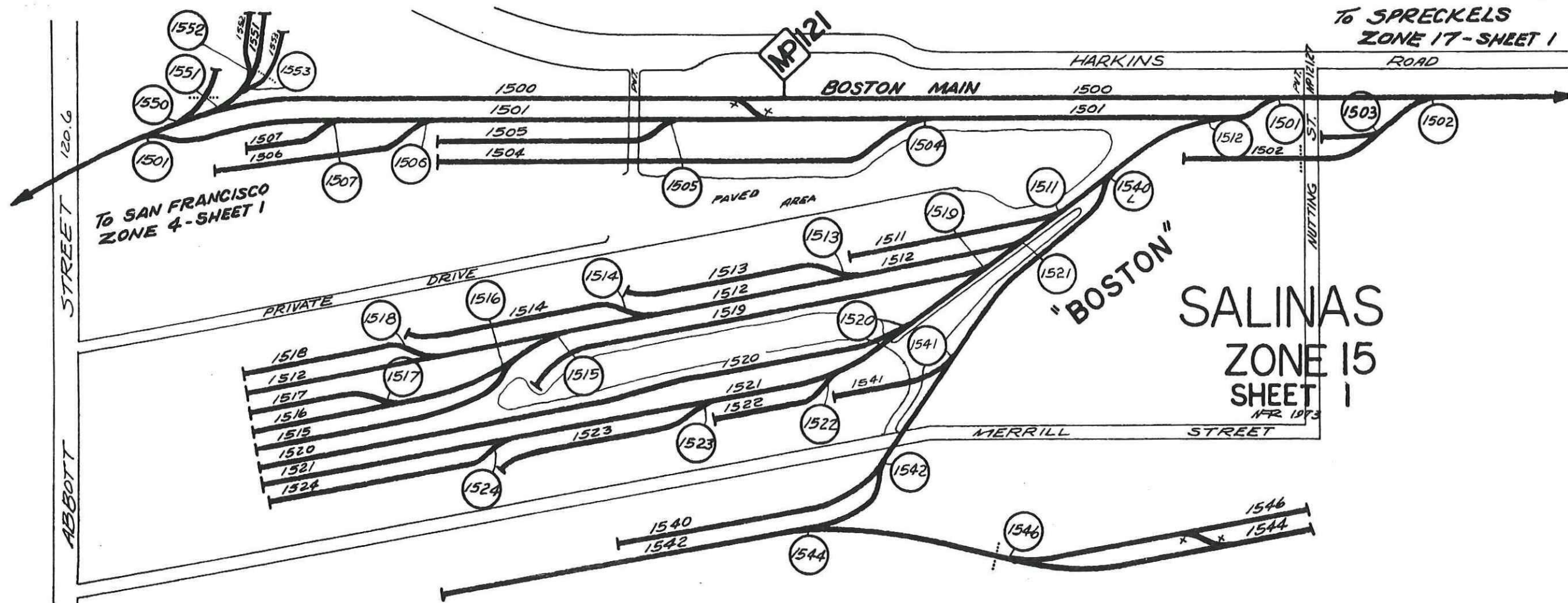

ZONE 16

<u>Track</u>	<u>Industry</u>	<u>Code/Spot</u>
1620	Lead Track	91
1621	Storage & Runaround	91
1622	Peter Paul	99,95/1-5
1623	Peter Paul	99 1,2
1640	Firestone Rubber Co. Runaround	91
1641	Firestone Lead Track	91
1642	Firestone (inside)	95 1-9
1644	Firestone Lead Track	95 1-5
1645	Firestone Lead Track	99 1-4
1646	Firestone	99 1-13
1647	Firestone	95 1-18
1648	Firestone	99 1-4

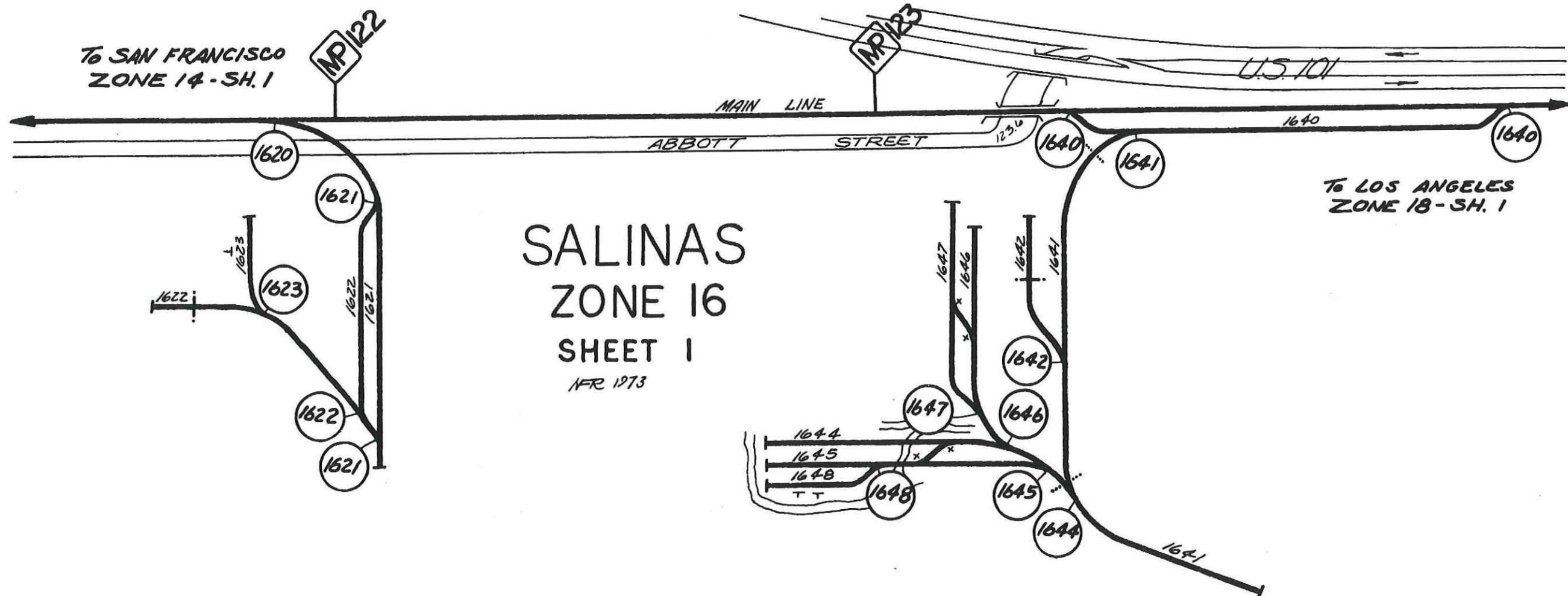

SALINAS
 ZONE 16
 SHEET 1
 APR 1973

ZONE 17

<u>Track</u>	<u>Industry</u>	<u>Code/Spot</u>
1700	Spreckels Main	
1701	Siding-Storage(89 cars)	91
1702	Storage (34 cars)	91
1703	Storage (34 cars)	91
1704	Storage (38 cars)	91
1705	Scale Track	91
1706	Water Track	91

To SAN FRANCISCO
ZONE 15
SHEET 1

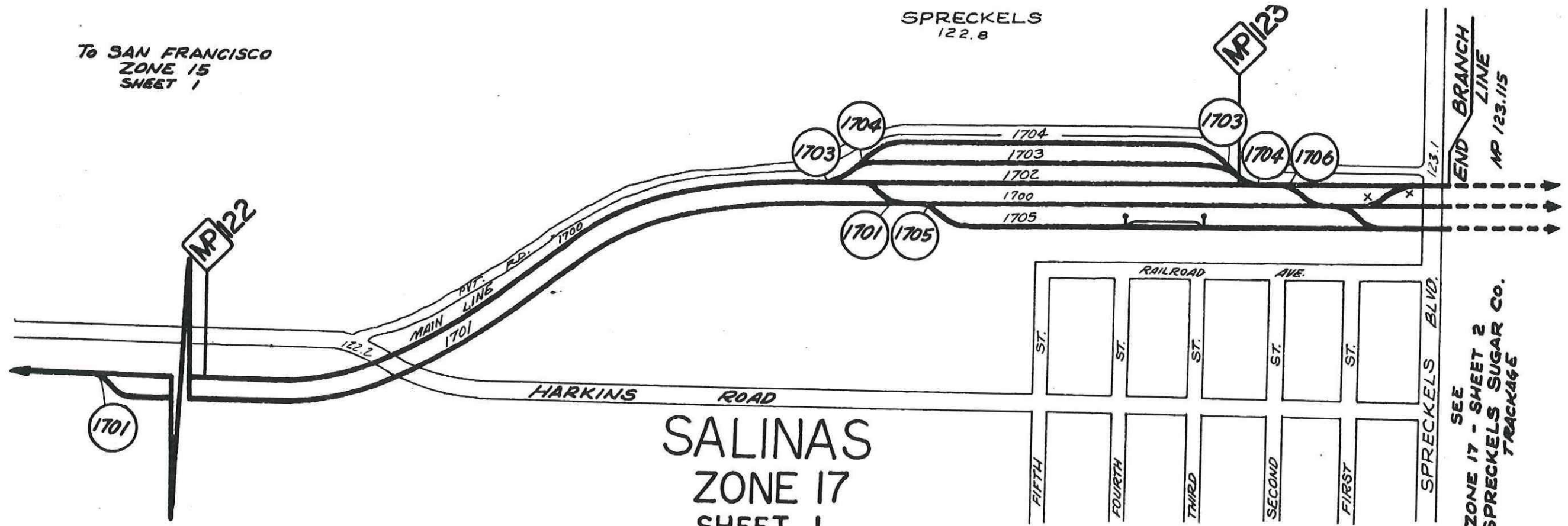

SALINAS
ZONE 17
SHEET 1

APR 1973

SEE
ZONE 17 - SHEET 2
SPRECKELS SUGAR CO.
TRACKAGE

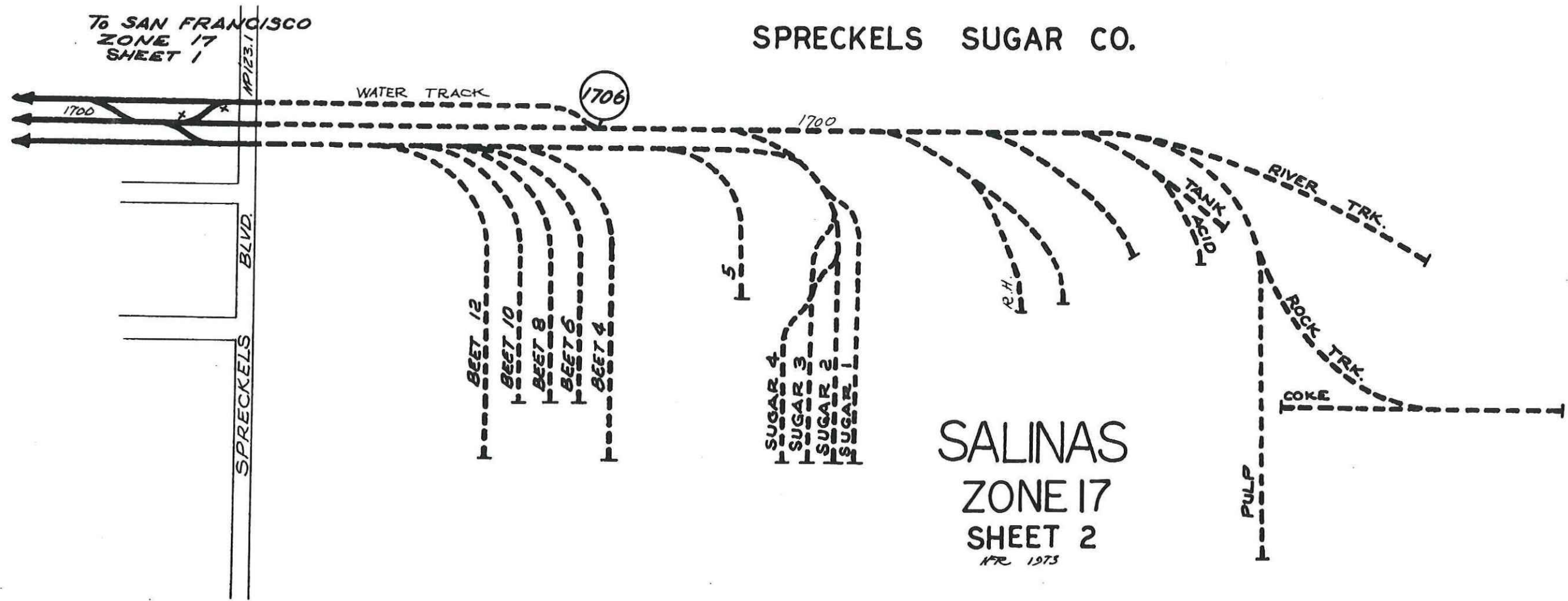

To SAN FRANCISCO
 ZONE 17
 SHEET 1

SPRECKELS SUGAR CO.

SALINAS
 ZONE 17
 SHEET 2
 APR 1973

ZONE 18

<u>Track</u>	<u>Industry</u>	<u>Code/Spot</u>
1800	Eckhart Seed	1
1800	Salinas Bean Co.	1
1801	Spence Siding (16 cars)	91
1802	Berman Steel	99 1,2,3,4
1802	E.B. Stone	95 1

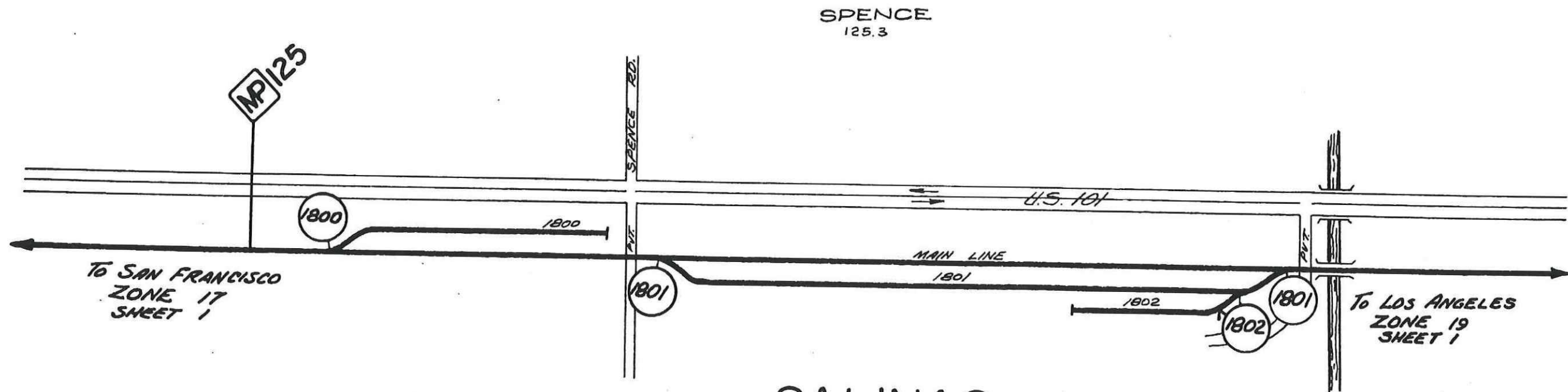

SPENCE
125.3

To SAN FRANCISCO
ZONE 17
SHEET 1

To LOS ANGELES
ZONE 19
SHEET 1

SALINAS
ZONE 18
SHEET 1
APR 1973

ZONE 19

<u>Track</u>	<u>Industry</u>	<u>Code/Spot</u>
1950	Chular Passing Track	
1955	Spreckels Sugar	1

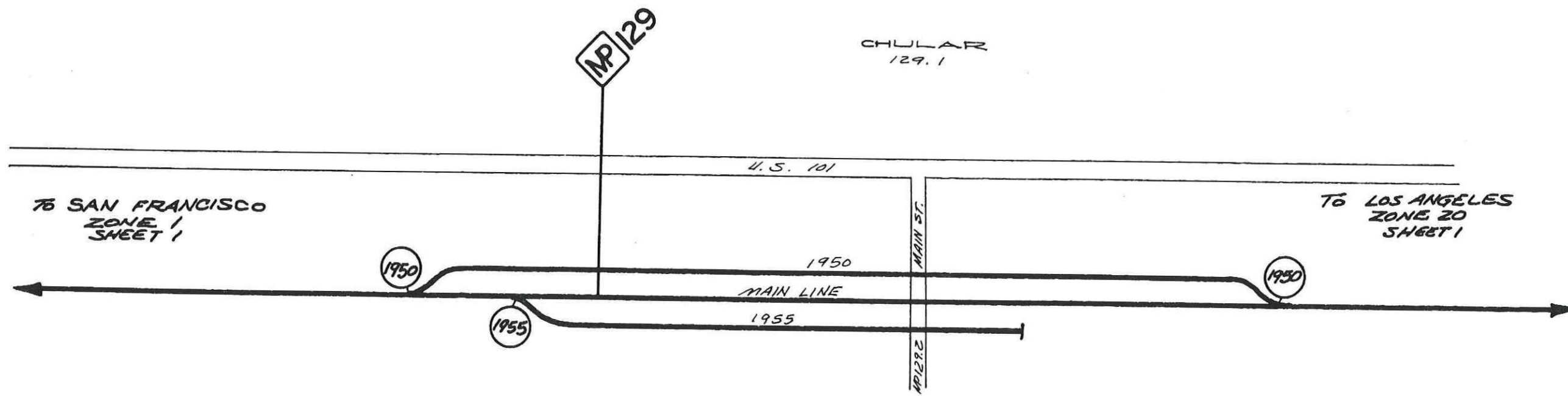

ZONE 19
SHEET 1
NFR 1973

ZONE 20

<u>Track</u>	<u>Industry</u>	<u>Code/Spot</u>
2018	Gonzales Potato Co.	99
2040	Gonzales Passing Trk.	
2042	M.B. Fowler Co.	
2044	Asgrow Seed Co.	
2045	Lead Track	
2045	Fat City Cattle Co.	
	(End)	94
2047	H.E. Hoffman Co.	99
2050	Runaround	
2050	Team Track	90
2050	The Garin Co.	99
2056	Gonzales Packing Co.	95

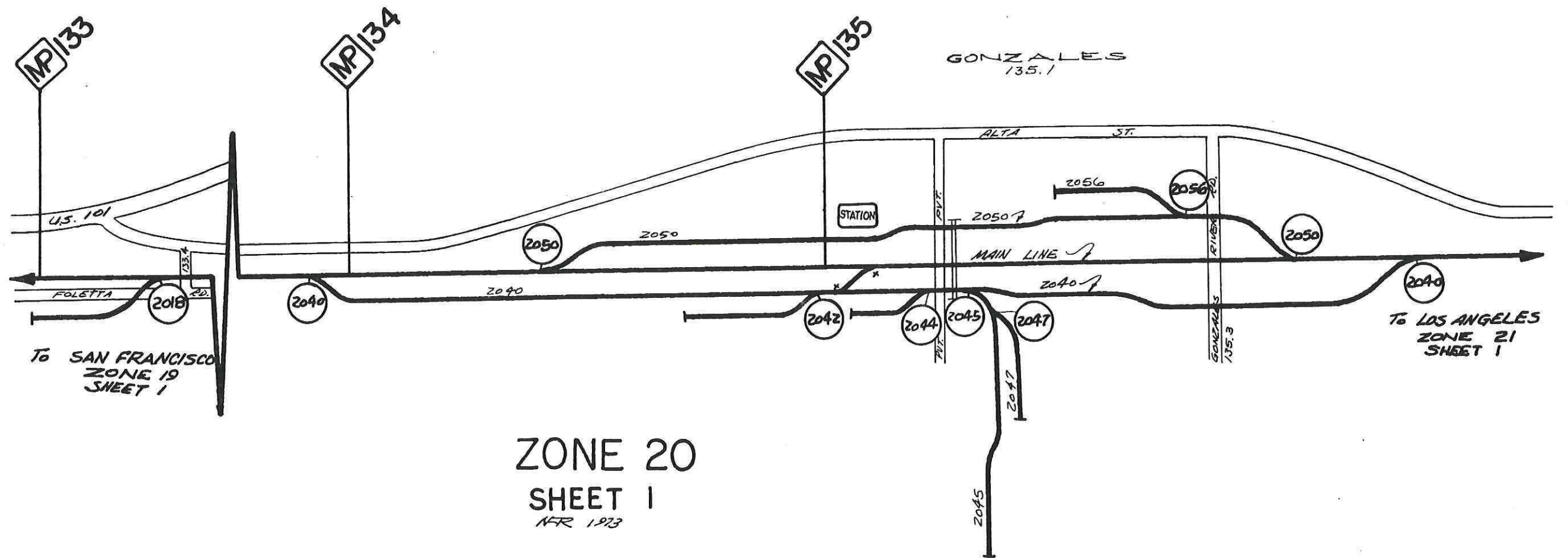

ZONE 20
 SHEET 1
 NFR 1973

ZONE 21

<u>Track</u>	<u>Industry</u>	<u>Code/Spot</u>
2137	O.P. Murphy & Sons	99
2150	Mitchell Silliman & Pryors Co.	95
2160	Union Sugar Co.	94

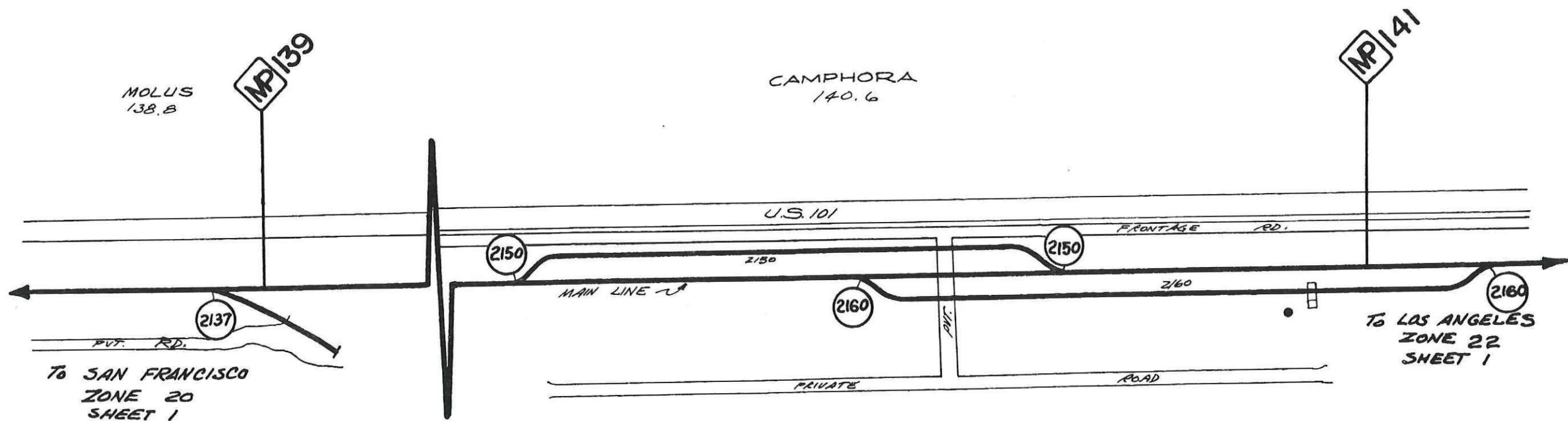

ZONE 21
 SHEET 1
 NFR 1973

ZONE 22

<u>Track</u>	<u>Industry</u>	<u>Code/Spot</u>
2230	Soledad Siding	
2230	Soledad Warehouse Co.	99
2238	B&P Packing Co.	99
2240	Passing Track	
2250	California Carrots Inc.	1,2,3
2260	Siding Number 2	
2270	House Track	91

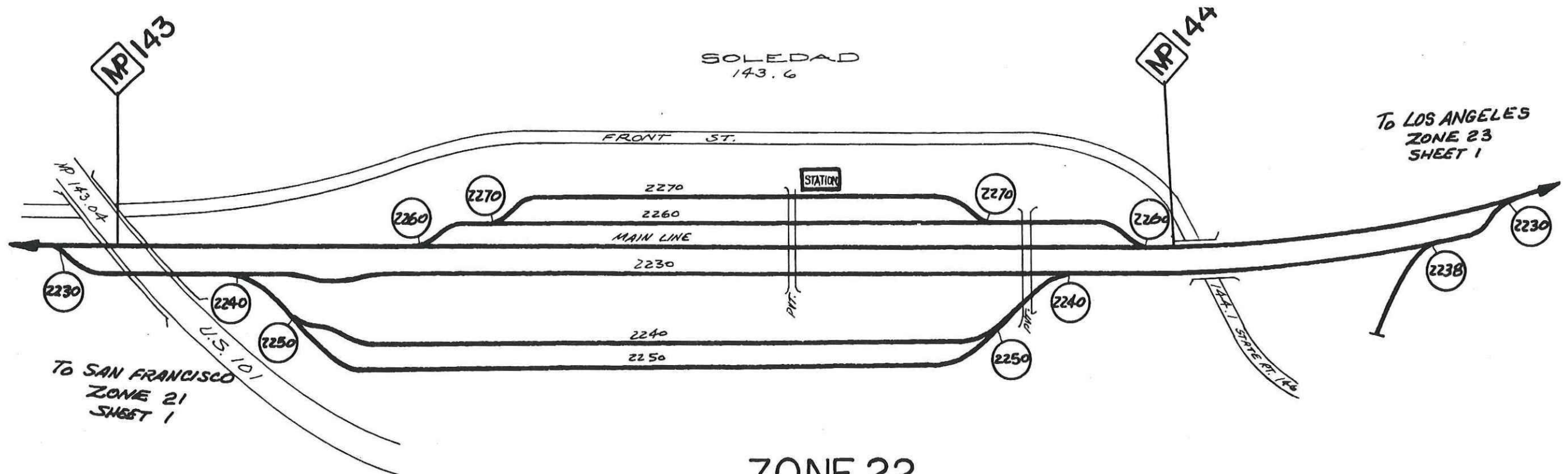

SOLEDAD
143.6

TO LOS ANGELES
ZONE 23
SHEET 1

TO SAN FRANCISCO
ZONE 21
SHEET 1

ZONE 22
SHEET 1
NFR 1973

ZONE 23

<u>Track</u>	<u>Industry</u>	<u>Code/Spot</u>
2330	Harlem Siding	
2360	Metz Siding	
2365	Basic Vegetable	95
2385	Spreckels Sugar	94

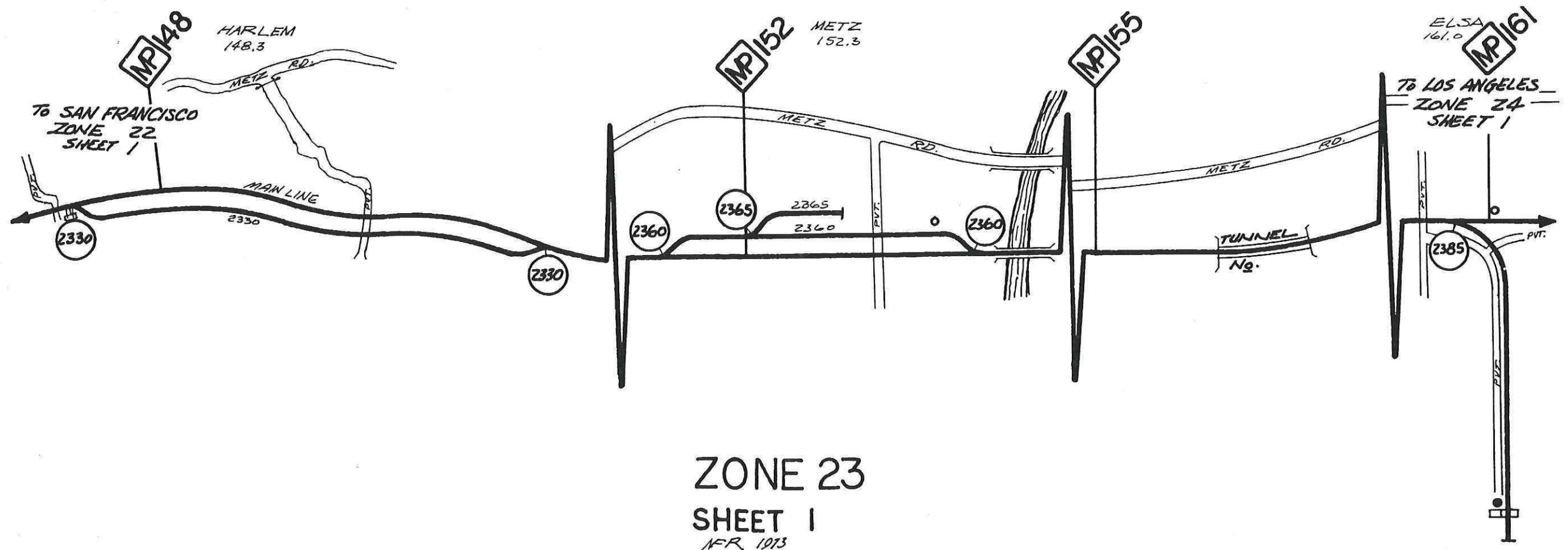

ZONE 23
 SHEET 1
 AFR 1973

ZONE 24

<u>Track</u>	<u>Industry</u>	<u>Code/Spot</u>
2420	Passing Track	
2430	Associated Track	91-99
2434	King City Cooler Spur	99
2435	Union Sugar	99
2437	Frudden Produce	
2440	Team Track	90
2442	Meyer Tomatoes	
2446	King City Whse Track	
2456	Maggio Carrots	99
2458	Maggio Carrots	95
2480	Short Siding	
2490	Union Carbide	95
2495	Union Carbide	99

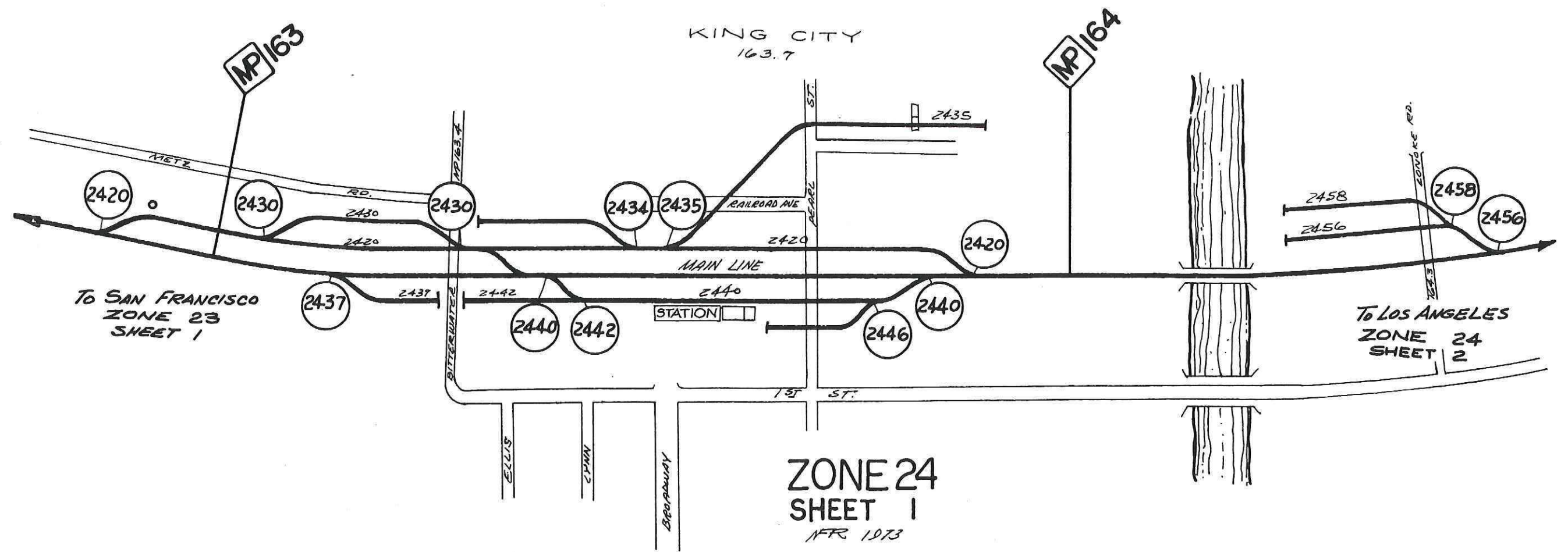

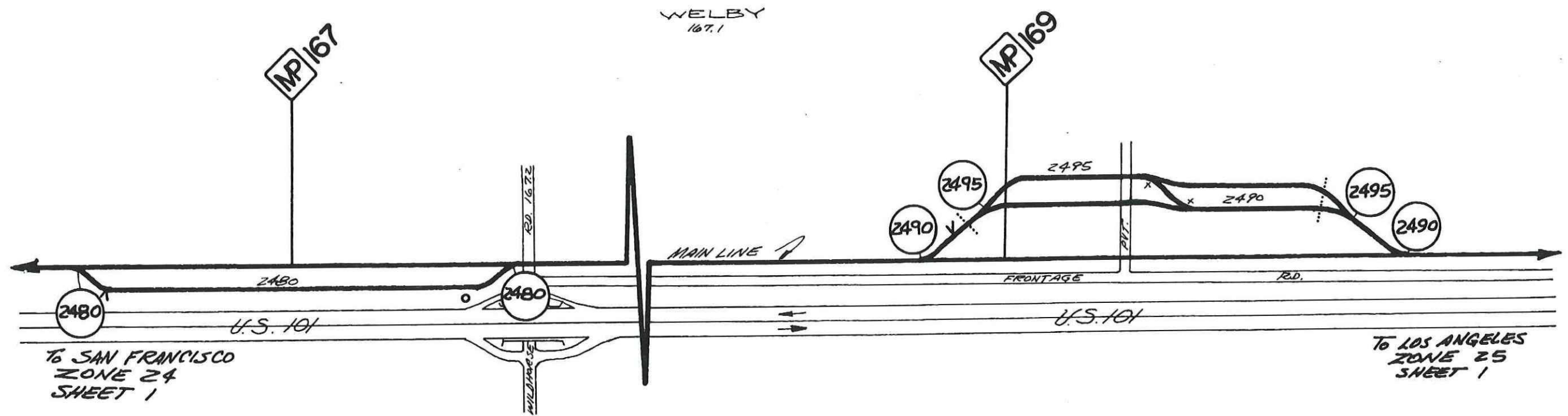

WELBY
167.1

To SAN FRANCISCO
ZONE 24
SHEET 1

To LOS ANGELES
ZONE 25
SHEET 1

ZONE 24
SHEET 2
NFR 1973

ZONE 25

<u>Track</u>	<u>Industry</u>	<u>Code/Spot</u>
2510	San Lucas Passing Trk.	
2517	Team Track	90
2518	Hearne Warehouse	95 1
2530	San Ardo Passing Trk.	
2540	Short Siding	
2540	Team Track	90
2550	Union Sugar	94
2570	Wunpost Passing Track	
2590	Bradley Passing Track	

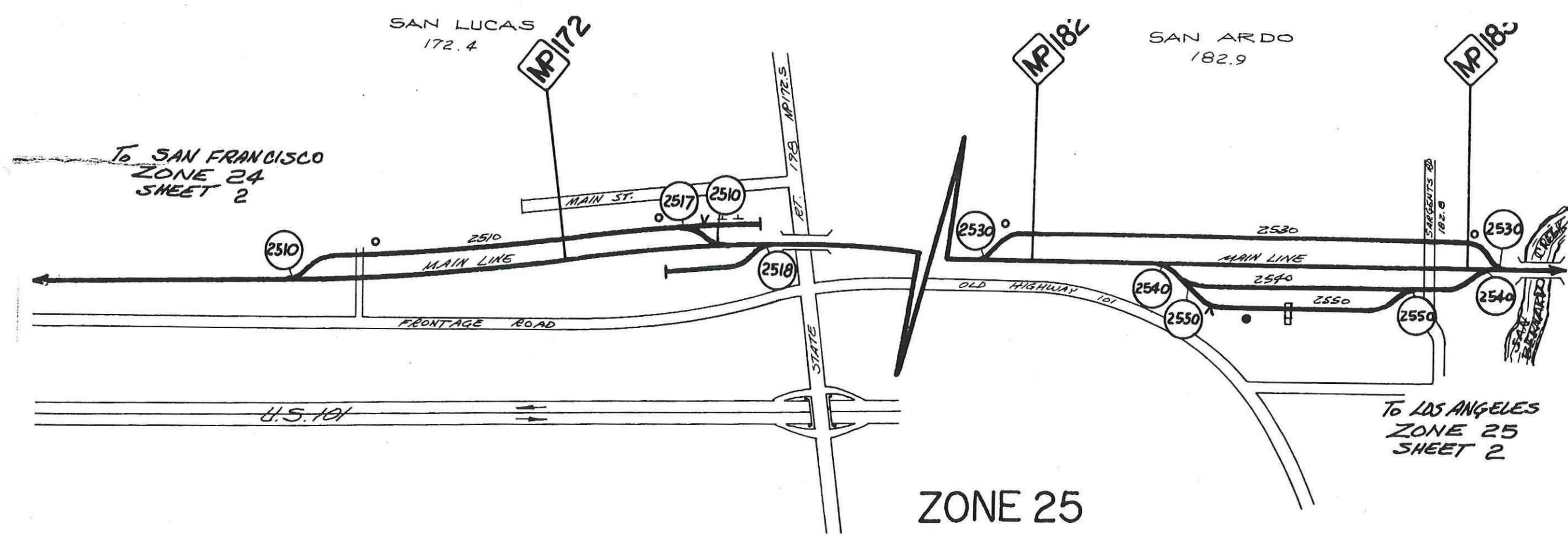

ZONE 25
SHEET 1
 APR 1973

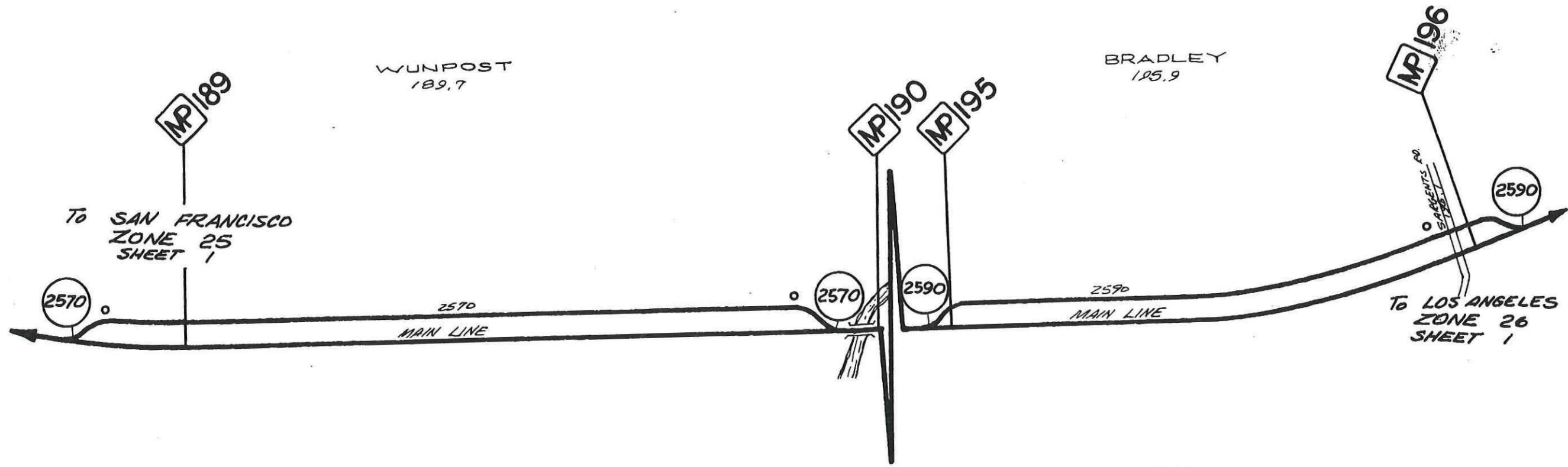

To SAN FRANCISCO
ZONE 25
SHEET 1

To LOS ANGELES
ZONE 26
SHEET 1

ZONE 25
SHEET 2
NFR 1973

ZONE 26

<u>Track</u>	<u>Industry</u>	<u>Code/Spot</u>
2637	U.S. Army (East Garrison)	97
2639	U.S. Army (East Garrison) Hold Track	99
2650	McKay #1 Siding	
2660	McKay #2 Siding	
2670	U.S. Army Lead (Spiked) Large Balloon	
2671	U.S. Army #1 Small Balloon	
2673	U.S. Army Large Ramp	97
2674	U.S. Army Oil Spur, Bldg. T-950	99
2675	U.S. Army Small Ramp	97
2676	U.S. Army #3	95
2677	U.S. Army #2	95
2678	U.S. Army-Tin or Scrap Track	99

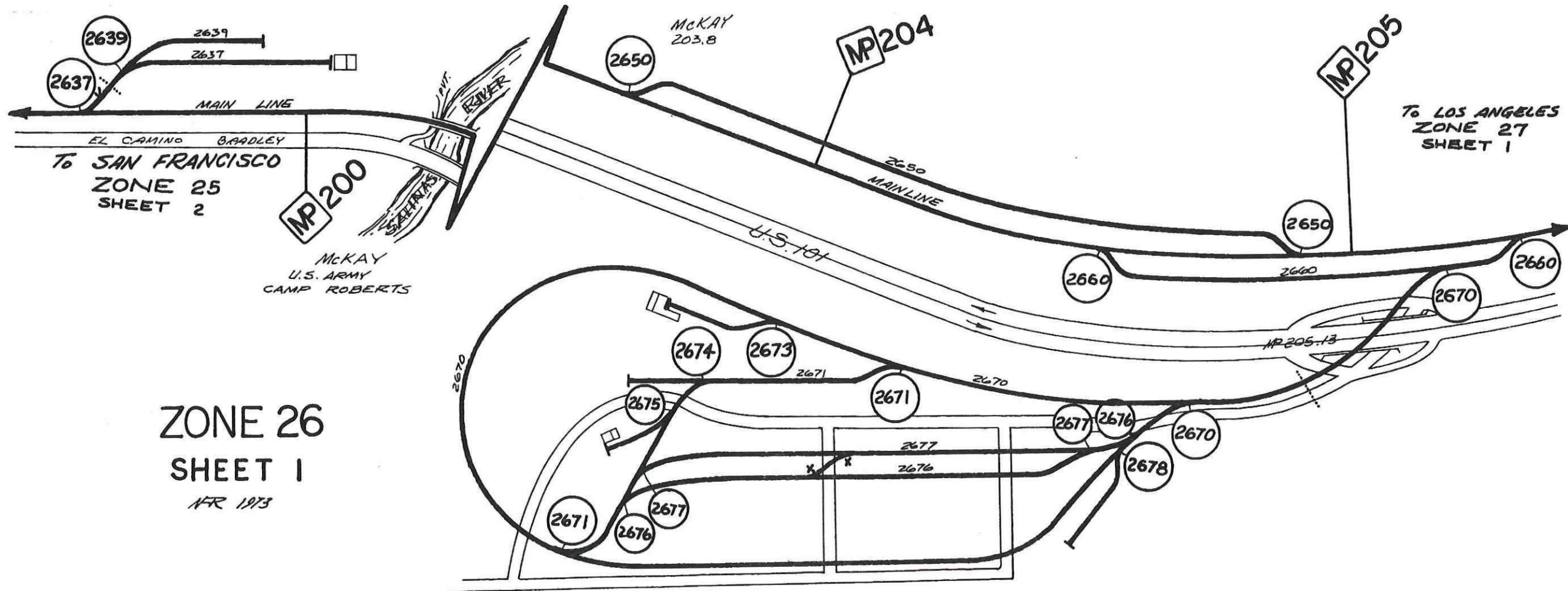

ZONE 26
 SHEET 1
 APR 1973

ZONE 27

<u>Track</u>	<u>Industry</u>	<u>Code/Spot</u>
2720	San Miguel Flour Mill (West End)	94
2720	Eaton & Smith Limerock (Conveyor)	94
2730	San Miguel Passing Trk	
2735	Team Track	90
2735	Stock Track	99
2750	Wellsona Passing Trk	
2760	Paso Robles Passing Trk	
2770	Stock Track	99
2770	Union Sugar Co.	94
2772	Pelton Spur	99
2774	Farmer's Alliance Lead	
2774	Team Track	90
2774	Farmer's Alliance F.A.B.A. (End)	
2775	Shell Oil (Abandoned)	99
2778	Almond Spur F.A.B.A.	95
2780	House Track	

<u>Track</u>	<u>Industry</u>	<u>Code/Spot</u>
2780	Hayward Lumber Co. (West End)	99
2782	M & W Spur	99
2784	Tractor Spur	97
2784	Team Track	90
2786	Hansen Spur	99
2788	Calif. Almond Orchards	99

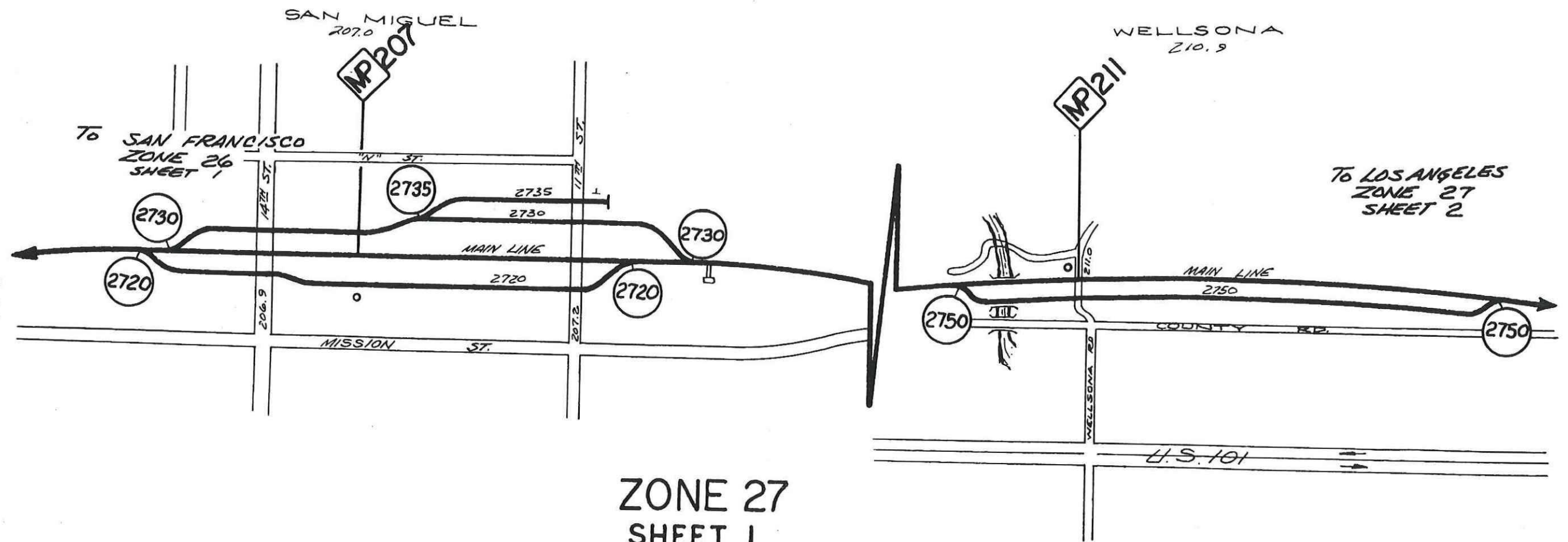

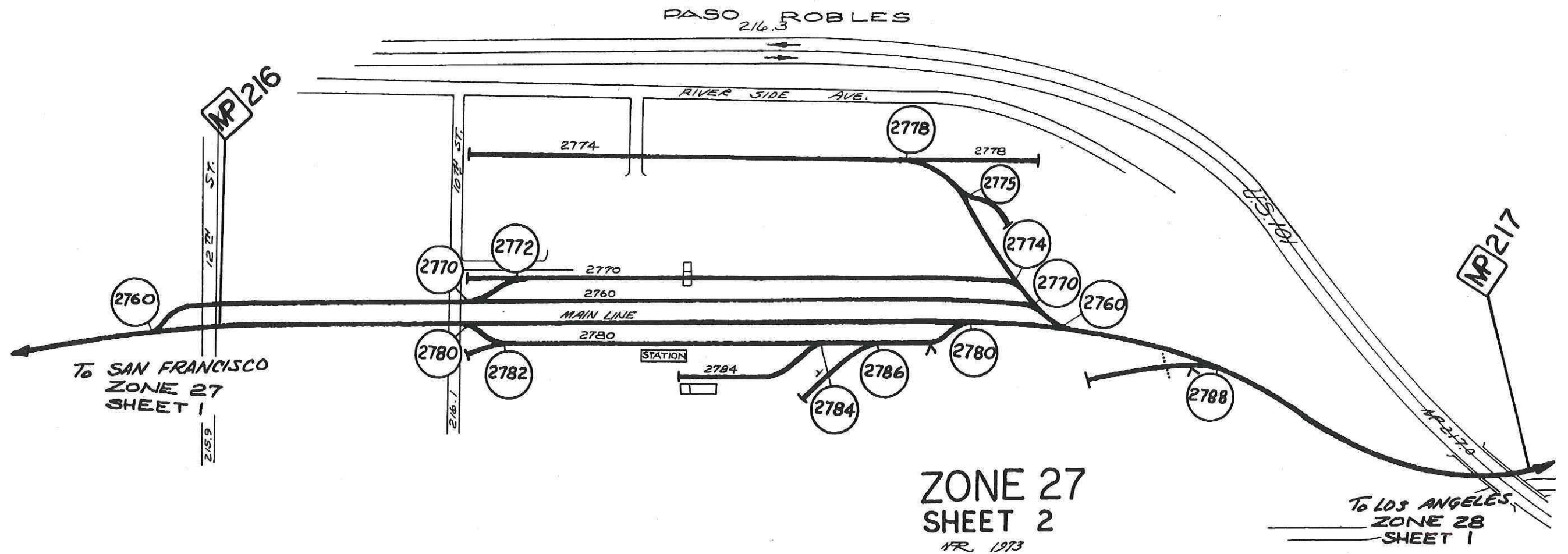

ZONE 28

<u>Track</u>	<u>Industry</u>	<u>Code/Spot</u>
2830	Templeton Passing Trk	
2837	Templeton Feed & Grain	95
2837	Team Track West of Pit	90
2853	Colony Spur	99
2855	P.C.A.	94
2855	Poultrymen's Co-Op Assn.	95
2858	Atascadero Team Track	90
2860	Henry Passing Track	
2880	Santa Margarita Passing Track	
2890	Corral Track Chute	10
2890	Santa Margarita Feed (Ralston Purina)	22,26
2890	Coors Distributors	31

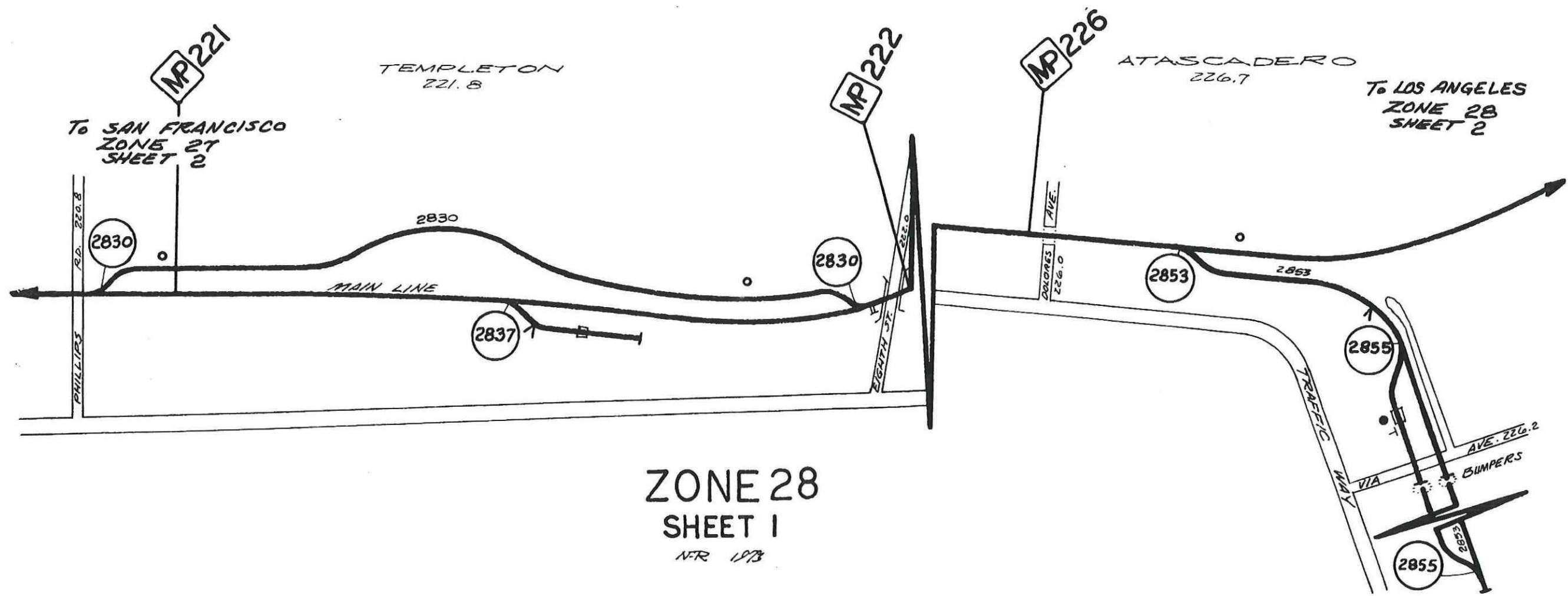

ZONE 28
SHEET 1
NFR 1978

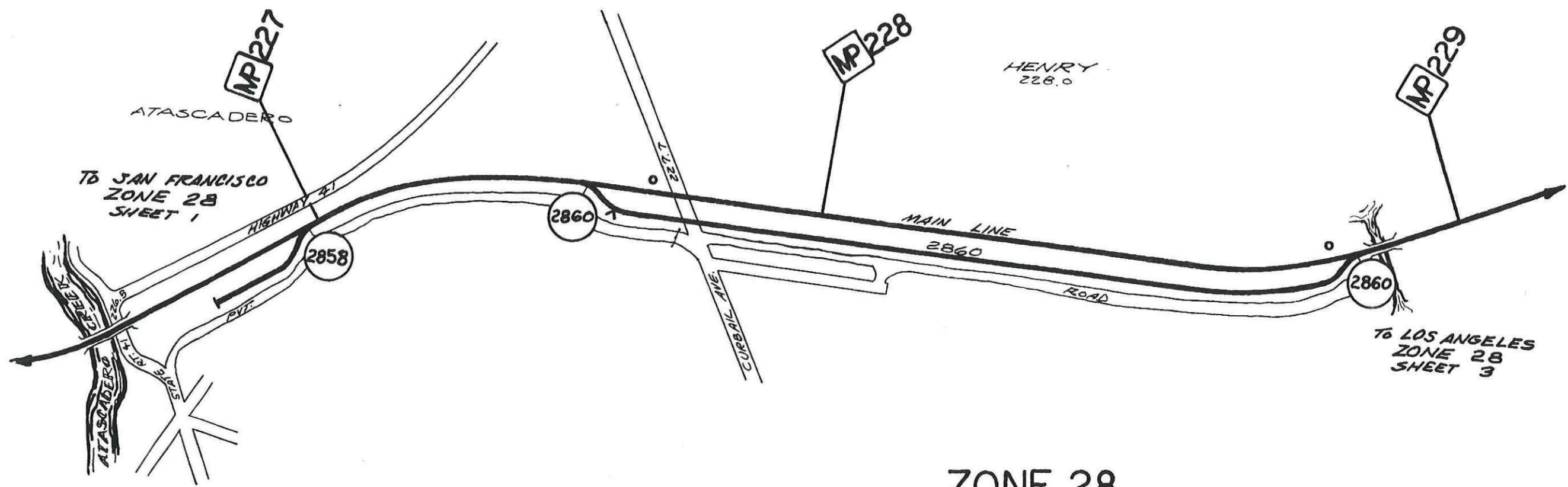

ZONE 28
SHEET 2
APR. 1973

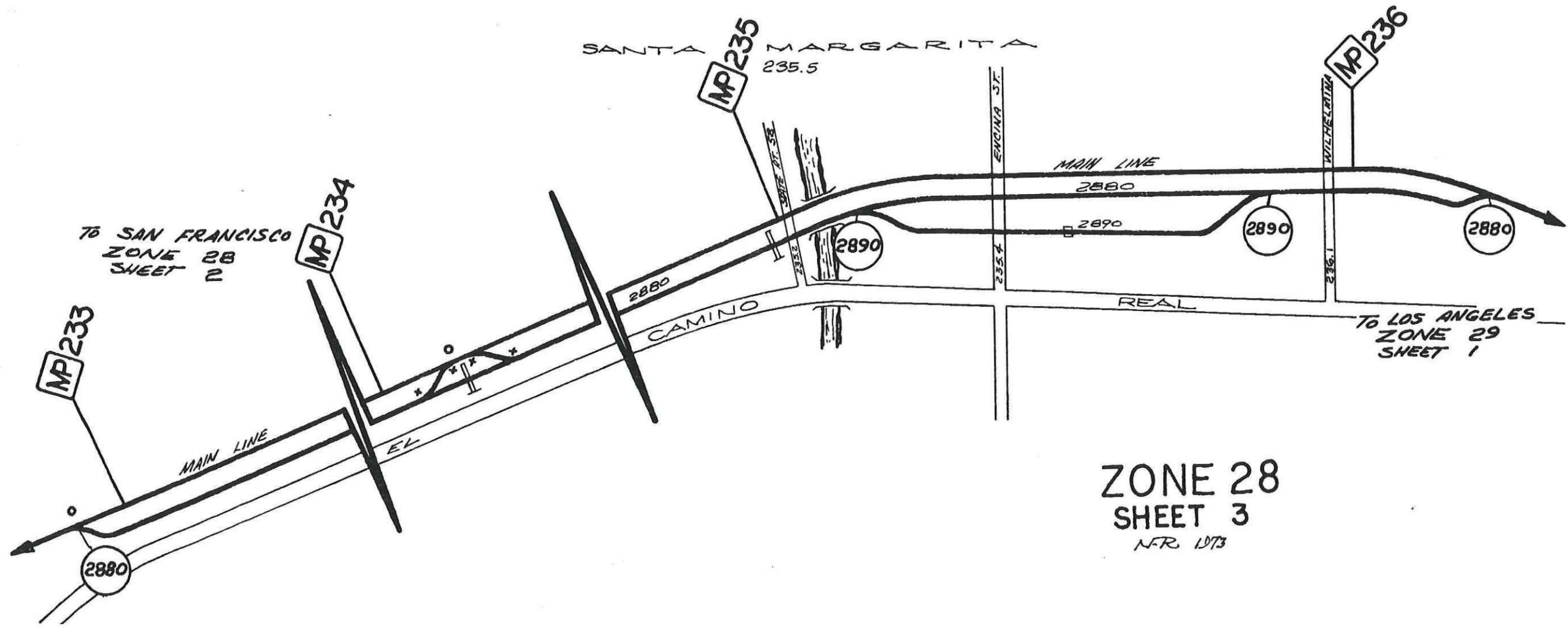

ZONE 28
SHEET 3
NFR 1973

ZONE 29

<u>Track</u>	<u>Industry</u>	<u>Code/Spot</u>
2920	Cuesta Passing Track	
2926	Storage Track	91
2940	Serrano Passing Track	
2960	Chorro Passing Track	
2961	Chorro N & W Spur	99
2990	Goldtree Passing Track	
2992	Goldtree Team Track	90,97
2995	Wye Track to Camp San Luis Obispo	

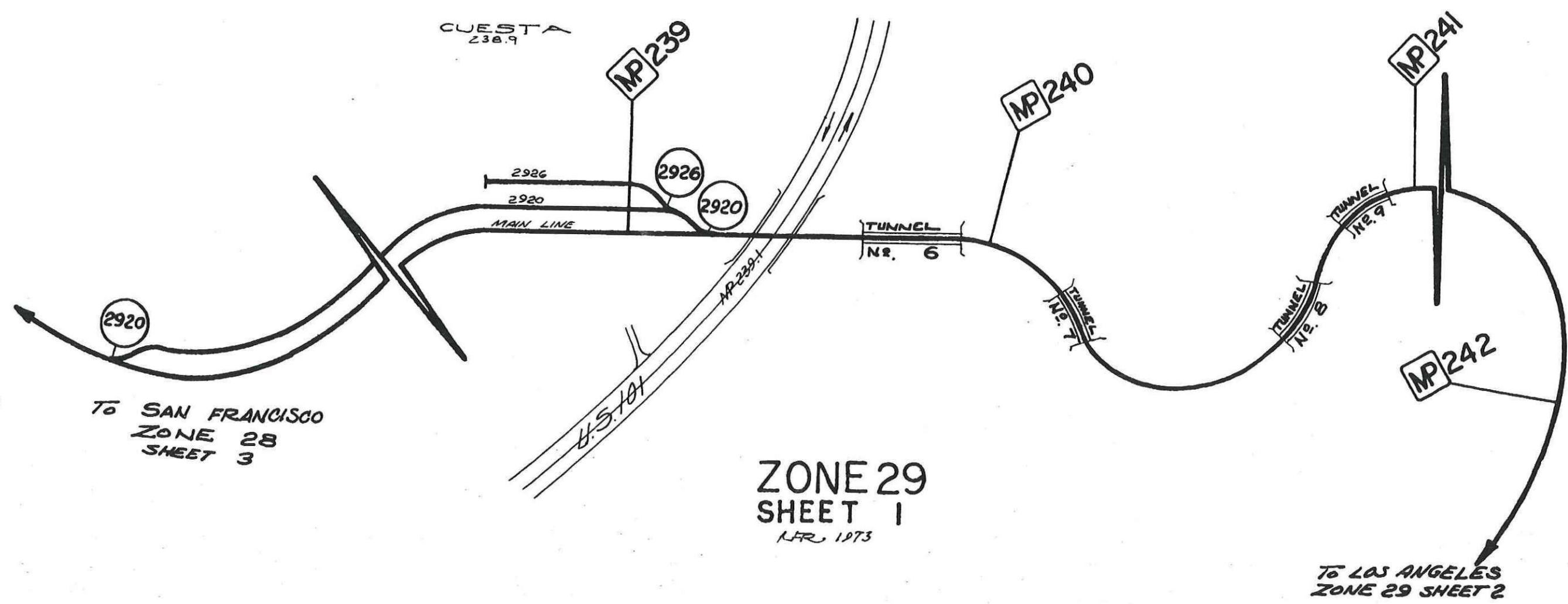

CUESTA
238.9

MP 239

MP 240

MP 241

MP 242

To SAN FRANCISCO
ZONE 28
SHEET 3

ZONE 29
SHEET 1
APR 1973

To LOS ANGELES
ZONE 29 SHEET 2

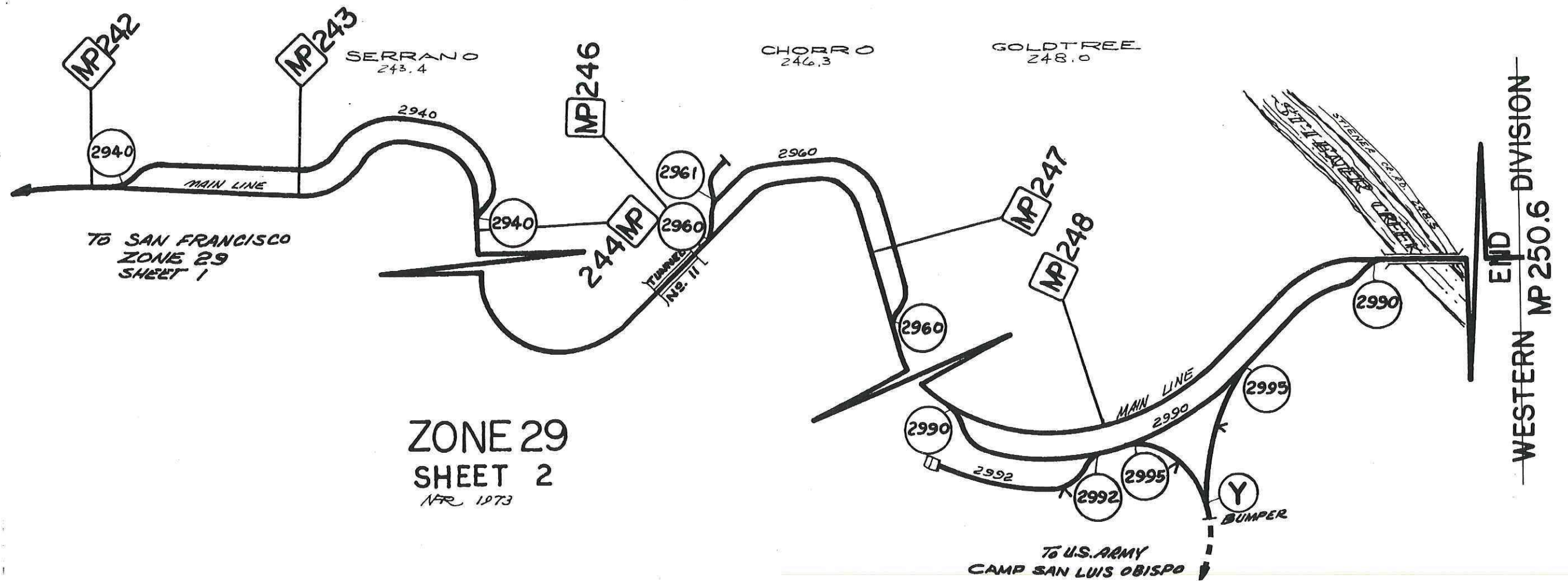

ZONE 29
SHEET 2
APR 1973

ZONE 30

<u>Track</u>	<u>Industry</u>	<u>Code/Spot</u>
3021	Prowse Feed	1,2,3
3023	Padula Lumber	99
3030	Perry Siding	
3035	McElroy Lumber	99
3050	Morgan Hill Siding	
3050	Gunter Feed (West End)	94,99 1,2
3052	Team Track	90
3052	Sunsweet	99 1-5
3052	Squeri Hardware	7,8
3053	Grief Brothers	1,7
3054	Clark's Container	1,2,3
3054	Boise Cascade	1,2,3
3056	Vacant	95
3057	Napa Industries	95
3059	Oakley Plywood	95-99
3061	Olin Mathieson	1-6
3064	Pic N' Pac	
3064	Western Refrigerator	99
3080	Runaround	

<u>Track</u>	<u>Industry</u>	<u>Code/Spot</u>
3080	Team Track	90
3083	San Martin Winery	1

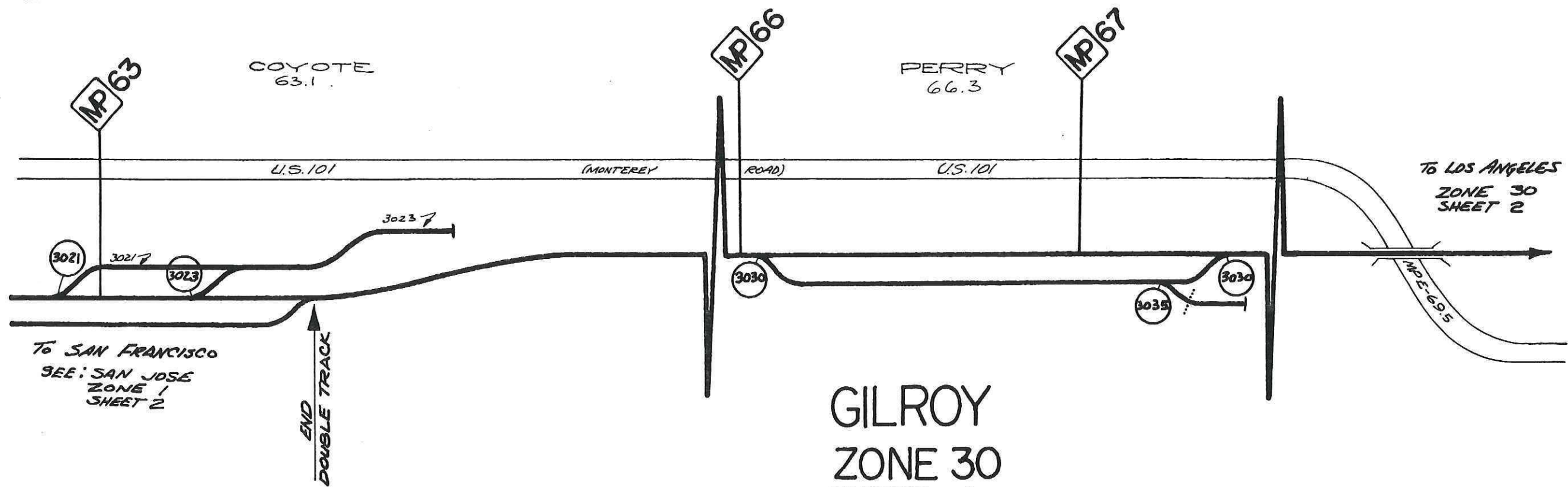

GILROY
 ZONE 30
 SHEET 1
 NFR 1973

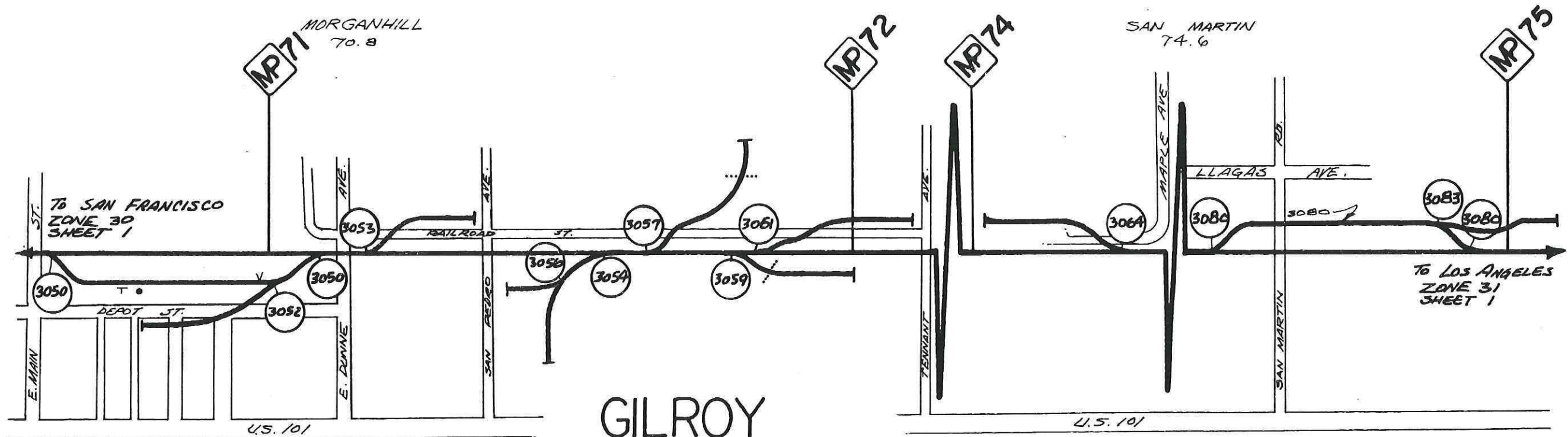

GILROY
 ZONE 30
 SHEET 2
 APR 1973

ZONE 31

<u>Track</u>	<u>Industry</u>	<u>Code/Spot</u>
3110	Rucker Passing Track	
3113	Los Animas Concrete & Bldg. Supply	99
3117	Certified Egg	
3121	Lead Track	
3123	Modular Homes	92,99
3127	Sunsweet	1
3131	Calif. Cannery & Growers (Gilroy Canning Co.) (Outside) Plant #1	99
3133	Calif. Cannery & Growers (Gilroy Canning Co.) (Inside) Plant #1	
3140	Storage Track	91
3143	Richmond Chase Plant#5	1,2
3145	Storage Track	91
3147	Shell Oil	1
3148	Pacific Central	1,2,3
3149	Pacific Central	1,2
3150	Runaround	

<u>Track</u>	<u>Industry</u>	<u>Code/Spot</u>
3151	Lead Track	
3151	Stockton Hay	99
3152	Team Track	90
3153	Gilroy Produce	95
3154	Gilroy Lumber	99
3157	Hirsma Warehouse	1
3159	Gilroy Foods, Inc.	1,2,3,4
3160	Center Siding	
3162	Gubsur Garlic	95
3167	Gentry Corp.	95
3175	Lead Track	
3175	Crown Zellerbach	95
3179	Vacant	99

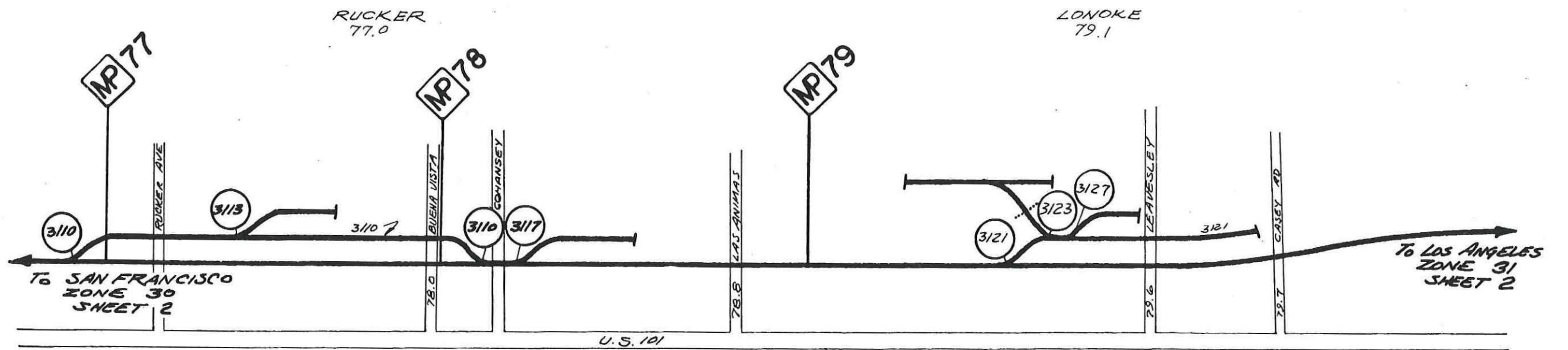

GILROY
 ZONE 31
 SHEET 1
 APR 1973

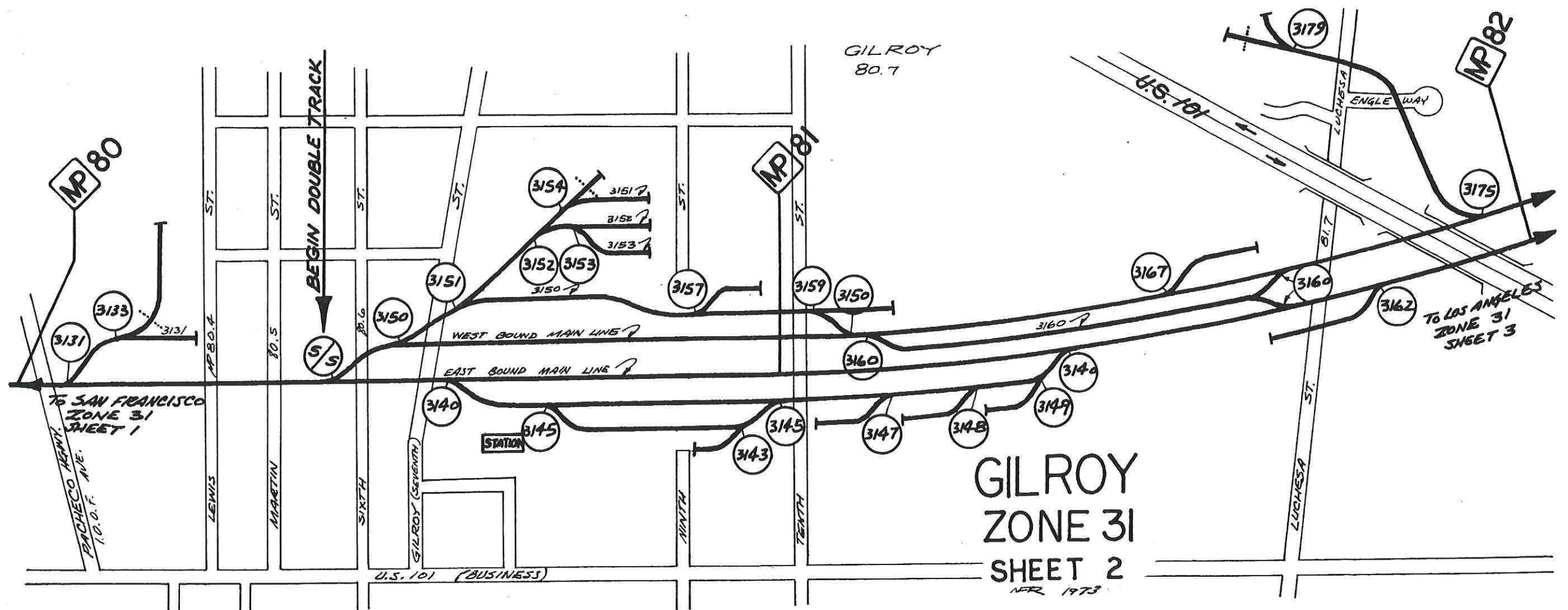

MP 80

GILROY
80.7

MP 81

MP 82

TO SAN FRANCISCO
ZONE 31
SHEET 1

TO LOS ANGELES
ZONE 31
SHEET 3

GILROY
ZONE 31
SHEET 2
NFR 1973

BEGIN DOUBLE TRACK

WEST BOUND MAIN LINE

EAST BOUND MAIN LINE

STATION

U.S. 101 (BUSINESS)

ENGLE WAY

LUCHESSA ST.

LEWIS ST.

MARTIN ST.

SIXTH ST.

GILROY (SEVENTH) ST.

NINTH ST.

TENTH ST.

LUCHESSA ST.

81.7

ST.

ST.

ST.

ST.

ST.

3131

3133

3131

3150

3151

3152

3153

3153

3154

3152

3153

3150

3157

3159

3150

3167

3160

3162

3140

3145

3143

3145

3147

3147

3148

3149

3149

3140

3179

3175

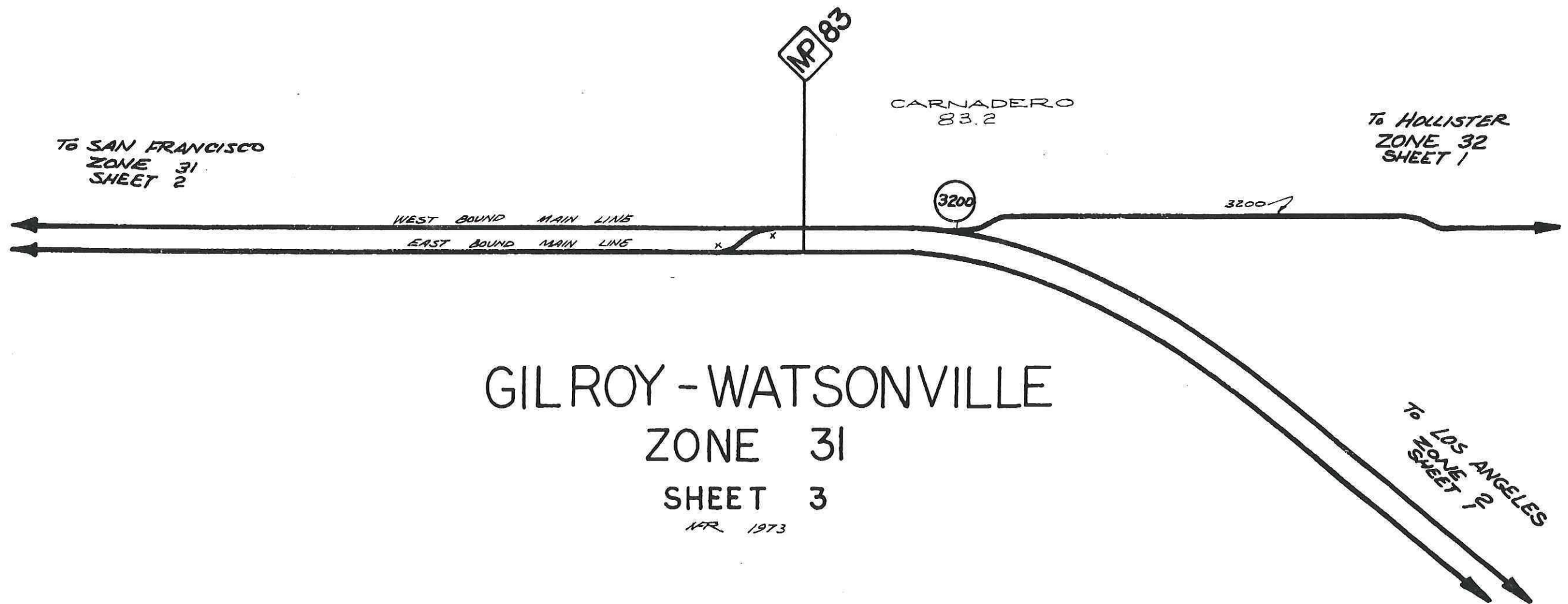

ZONE 32

<u>Track</u>	<u>Industry</u>	<u>Code/Spot</u>
3200	Hillister Branch	
3220	Spreckels Sugar Beet Dump	94
3253	Hayward Lumber Co.	99
3257	National Can Co.	95
3259	National Can Co.	95
3262	Storage Track	91
3263	Lead Track	
3264	Nicolet Paper Co.	99
3265	Fertz Apur	99
3269	Hollister Ice Co.	99
3270	House & Passing Track	
3276	Hollister Feed	94
3282	Lead Track	99
3282	Hollister Can Co.	99
3284	Hollister Feed	
3286	Old Lumber Yard	99
3292	Shell Oil Co.	99
3297	Dolomite Spur	99

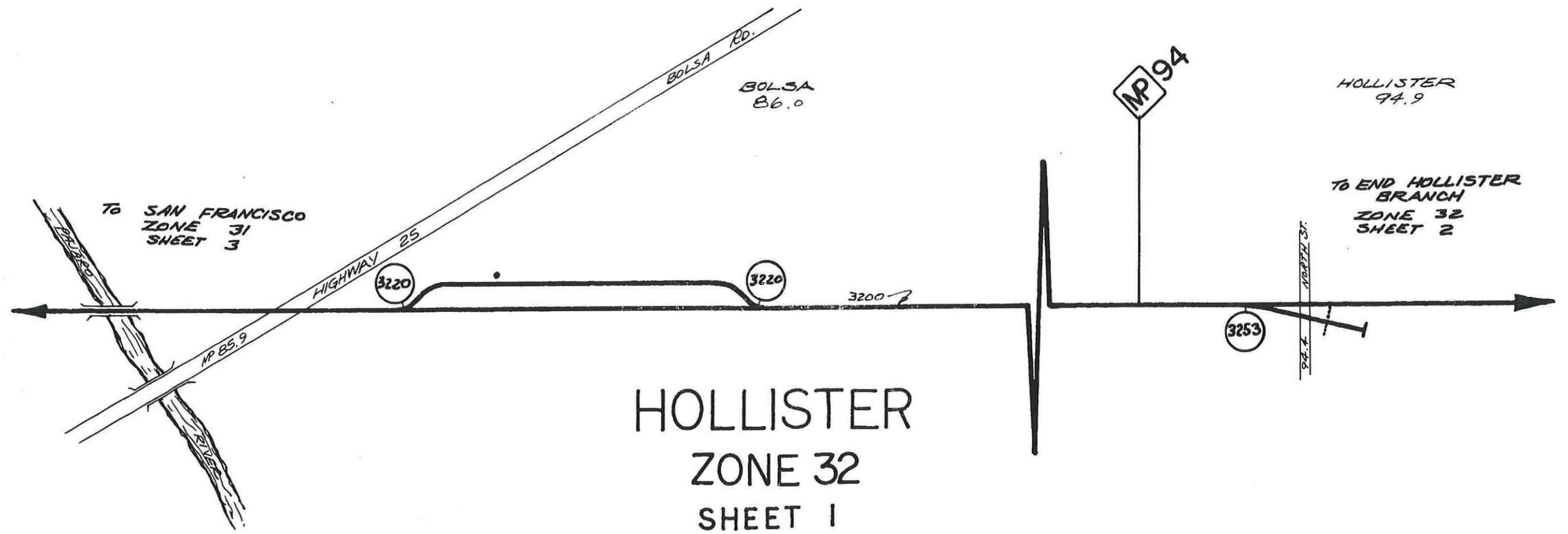

APR 1973

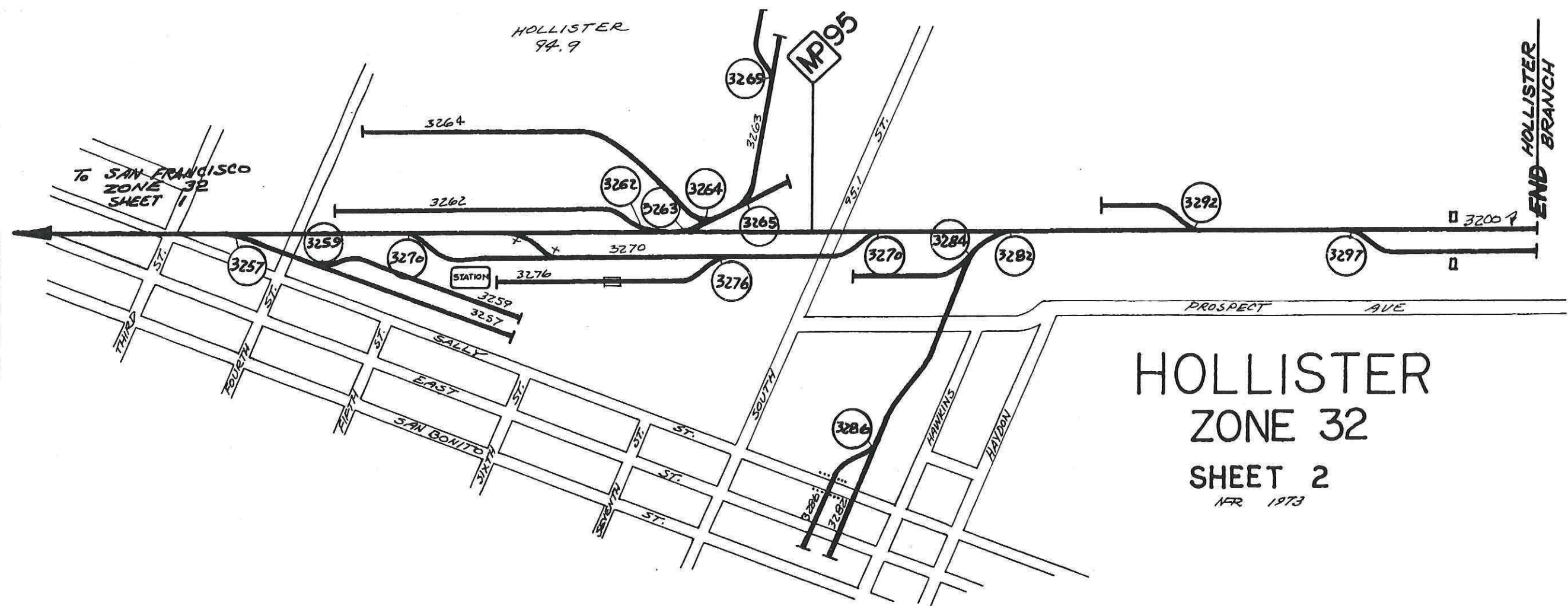

HOLLISTER
ZONE 32
SHEET 2
APR 1973